

## IT83 Series Indoor Monitor Admin Guide

## About This Manual

Thank you for choosing Akuvox's IT83 series indoor monitor. This manual is intended for end users, who need to use and configure the indoor monitor. This manual provides an introduction of all functions and features of the product. It is suitable for 83.31.2.3xx version. Please visit Akuvox forum or consult technical support for any new information or latest firmware.

**Note:** Please refer to universal abbreviation form in the end of manual when meet any abbreviation letter.

# Content

<b>1. Product Overview.....</b>	<b>1</b>
1.1. Product Description.....	1
1.2. Connector Introduction.....	2
<b>2. Daily Use.....</b>	<b>3</b>
2.1. Starting.....	3
2.2. Making a Call.....	5
2.2.1. Calling from Call List.....	5
2.2.2. Calling from All Call.....	5
2.2.3. Calling from Missed Call.....	6
2.2.4. Calling from Device.....	7
2.2.5. Calling from LocalPhoneBook.....	7
2.2.6. Calling from Keypad.....	8
2.3. Receiving a Call.....	8
2.3.1. Receive an Incoming Call.....	8
2.3.2. During the session.....	9
2.4. Monitor.....	9

2.4.1. Checking the Monitor.....	10
2.5. Message.....	11
2.5.1. Text Message.....	11
2.5.2. Creating a Message.....	12
2.5.3. Deleting a Message.....	13
2.6. Arming.....	14
2.6.1. Arming Mode.....	14
2.6.2. Disarm Code.....	15
2.6.3. Alarm Log.....	16
2.6.4. Status.....	16
<b>3. Basic Features.....</b>	<b>17</b>
3.1. Accessing the System Settings.....	17
3.1.1. Advanced System Setting.....	17
3.2. Accessing the Website Setting.....	17
3.2.1. Obtaining IP address.....	17
3.2.2. Accessing the Device Website.....	18
3.3. Password Modification.....	18

3.3.1. System Code Modification.....	18
3.3.2. Setting Code Modification.....	19
3.3.3. Web Password Modification.....	19
3.4. Phone Configuration.....	20
3.4.1. Language.....	20
3.4.2. Time.....	20
3.4.3. Network.....	22
3.4.3.1. Network Status.....	22
3.4.3.2. Network Settings.....	23
3.4.3.3. WIFI Setting (optional).....	24
3.4.3.4. Local RTP.....	24
3.4.4. Display Settings.....	24
3.4.5. Sound Settings.....	25
3.4.6. Door Bell Sound.....	26
3.4.7. DND.....	27
3.4.8. Capture.....	28
3.4.9. Logo.....	28

3.4.10. Key Set of IT83X Monitor.....	29
3.5. Local PhoneBook.....	30
3.5.1. Adding a Contact.....	30
3.5.2. Editing a Contact.....	31
3.5.3. Contact Import/Export.....	32
3.5.4. Black List.....	32
3.6. Intercom Call.....	34
3.6.1. IP Direct Call.....	34
3.6.2. SIP Call.....	34
3.6.3. Account Status.....	35
3.6.4. SIP Account.....	36
3.6.5. SIP Server.....	37
3.6.6. Outbound Proxy Server.....	37
3.6.7. Transport Type.....	38
3.6.8. Auto answer.....	38
3.6.9. Assistance call.....	39
3.6.10. Multicast.....	40

3.7. Security.....	41
3.7.1. Monitor Settings.....	41
3.8. Access control.....	42
3.8.1. Face ID.....	42
3.8.2. Local Relay.....	43
3.8.3. Remote relay.....	44
3.8.4. Reboot.....	44
3.8.5. Reset.....	45
<b>4. Advanced Features.....</b>	<b>46</b>
4.1. Phone Configuration.....	46
4.1.1. Installing Custom APK.....	46
4.1.2. Discovery setting.....	47
4.2. Intercom.....	48
4.2.1. Call Forwarding.....	48
4.2.2. Intercom.....	49
4.2.3. Subscribe.....	50
4.2.4. Audio Codec.....	50

4.2.5. Video Codec.....	51
4.2.6. NAT.....	51
4.2.7. User Agent.....	52
4.2.8. DTMF.....	52
4.2.9. Encryption.....	53
4.2.10. Call Related.....	53
4.2.11. Remote Control.....	54
4.2.12. Session Time Out.....	54
4.3. Access Control.....	55
4.3.1. Web Relay.....	55
4.3.2. Remote Relay by HTTP.....	55
4.4. Security.....	56
4.4.1. Arming Zone Setting.....	56
4.4.2. Motion Detector.....	57
4.5. Upgrade.....	58
4.5.1. Basic Upgrade.....	58
4.5.2. Autop.....	58



4.5.2.1. PNP Autop.....	59
4.5.2.2. DHCP Autop.....	59
4.5.2.3. Manual Autop.....	60
4.5.2.4. Automatic Autop.....	61
4.6. Logs.....	61
4.6.1. Call log.....	61
4.6.2. System Log.....	62
4.6.3. PCAP.....	62

# 1. Product Overview

## 1.1. Product Description

IT83X is an Android SIP-based with smooth touch-screen indoor monitor. It can be connected with Akuvox door phone for audio/video communication, unlocking and monitoring.

Residents can communicate with visitors via audio/video call, and it supports to unlock the door remotely. It is more convenient and safer for residents to check the visitor's identity through its video preview function.

IT83X are often applied to scenarios such as villas, apartments and buildings.

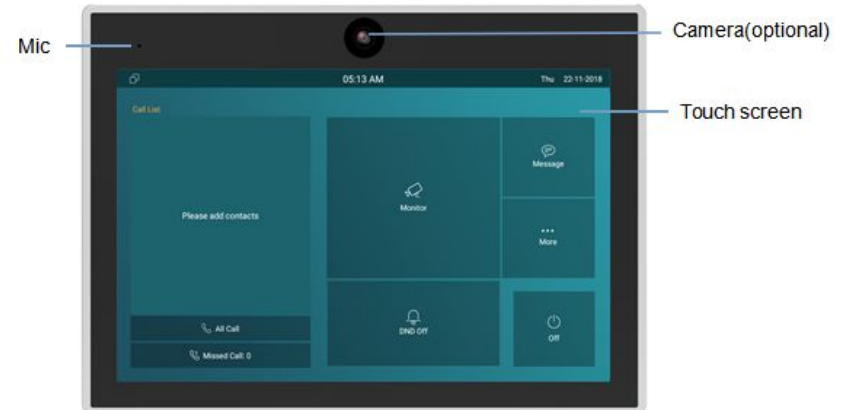

## 1.2. Connector Introduction

**Ethernet (POE):** Ethernet (POE) connector which it can provide both power and network connection.

**RJ45 (PON):** Share the network access from Ethernet (POE) port, and for PC and other equipments connection.

**12V/GND:** External power supply terminal if POE is not available.

**RS485A/B:** RS485 terminal.

**Bell/GND:** Connect a simple two-wire door bell.

**Relay A/B (NO/COM/NC):** Relay control terminal.

**IO1- IO8/GND:** Connect with different alarm detectors for 8 security zones.

**Note:** The general indoor monitor interface diagram is only for reference.

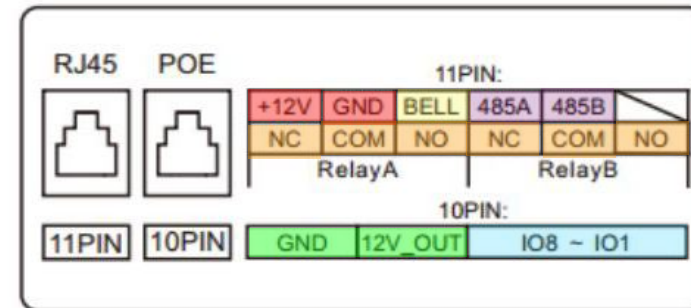

Figure 1.2-1 IT83X interface

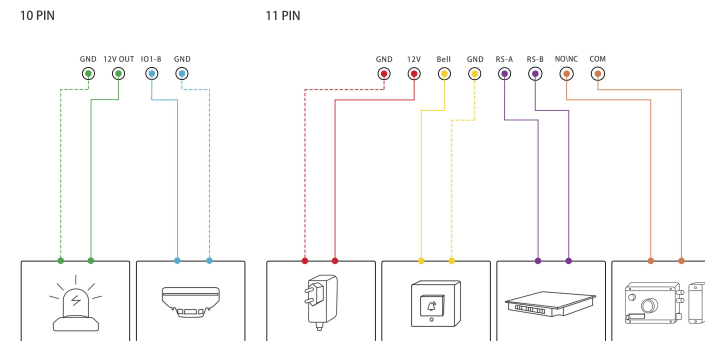

Figure 1.2-2 General interface

## 2. Daily Use

### 2.1. Starting

When booting IT83X first time, users need to choose a suitable way to connect to network, wireless or wire.

To choose a proper device mode according to specific application scenarios. IT83X supports 3 modes, including **Cloud**, **Discovery** and **SDMC**. It only pop up Cloud Mode and Discovery Mode for users choosing. Tap **Skip** if users are adopting SDMC mode. Discovery mode is default mode if you don't choose any device mode.

**Discovery mode:** It is a plug and play configuration mode. Akuvox devices will configure themselves automatically when users power on the devices and connect them to network. It is super time-saving mode and it will greatly bring users convenience by reducing

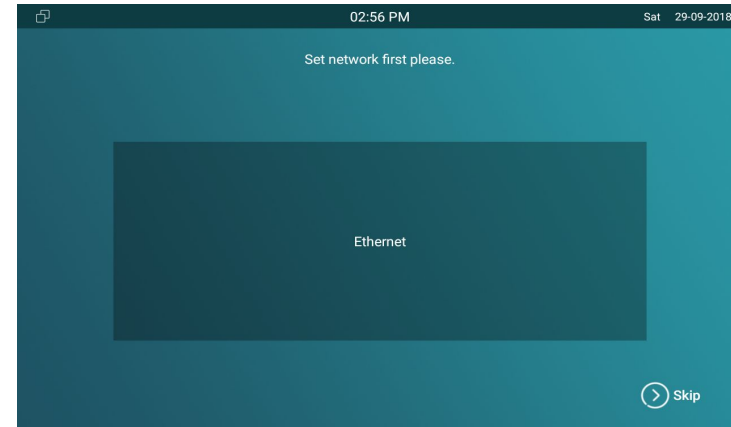

Figure 2.1-1 Network selection

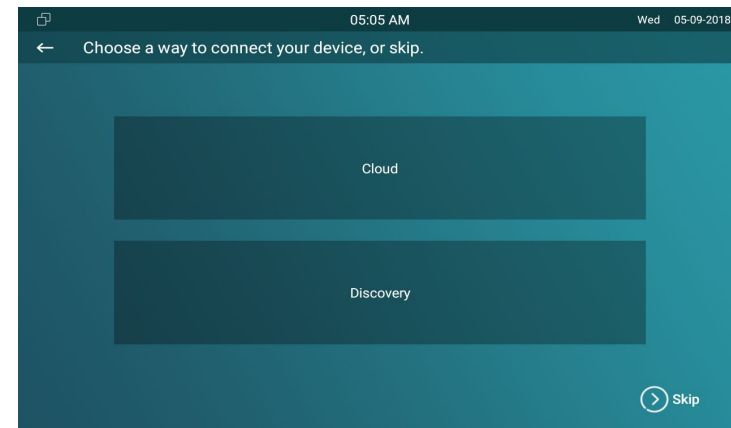

Figure 2.1-2 Device mode selection

manual operations. This mode do not need to be done any configurations previously by the administrator.

**Cloud mode:** Akuvox Cloud is an all in one management system. Akuvox Cloud is the mobile service that allows audio, video, remote access control between smart phones and Akuvox intercoms. All configurations in the device will be issued automatically from cloud. If users decide to use Akuvox cloud, please contact administrator, who will help to configure related settings before using.

**SDMC mode:** SDMC is a center management software which is suitable for managing a community in LAN. The device will get settings from SDMC automatically.

## 2.2. Making a Call

There are 6 ways to establish VOIP calls by IT83X.

### 2.2.1. Calling from Call List

In the home page, choose a number from **Call List** to make a call.

- Scroll up or down the **Call List** to choose the contact that users want to call.

**Note:** In Cloud or SDMC mode, the **Call List** of IT83X will be issued from the system.

### 2.2.2. Calling from All Call

In the home page, it could call multiple indoor monitors if they are set under the same multicast address. During the session, IT83X is listened by other indoor monitors.

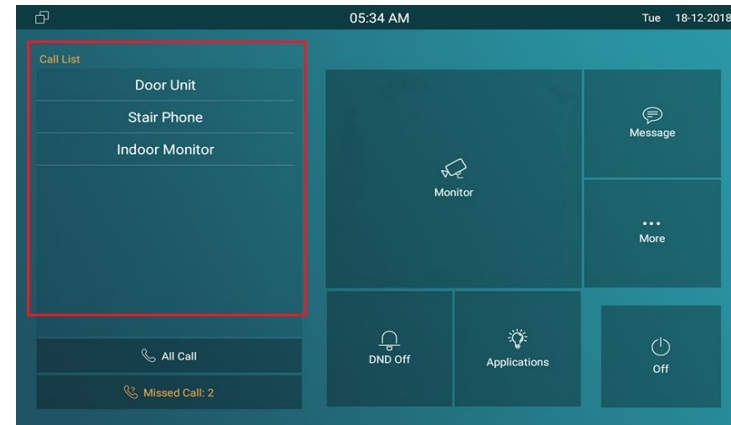

Figure 2.2.1-1 Call from call list

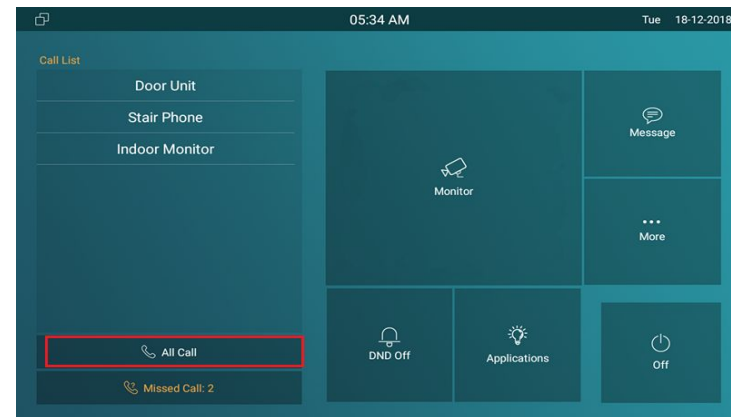

Figure 2.2.2-1 Call from all call

- Tap **All Call** icon to call other indoor monitors which are set in the same multicast group.

### 2.2.3. Calling from Missed Call

In the home page, missed call indicates how many calls that users missed (1 missed call for an example). Missed call could be treated as a brief call log.

- Tap **Missed Call** icon ① to view the calls that were not answered before.
- Choose the contact on the call list ② which users want to call out.
- Click account above the keypad ③ to switch accounts to make a call.
- Choose **Audio** ④ or **Video** ⑤ mode to call out.

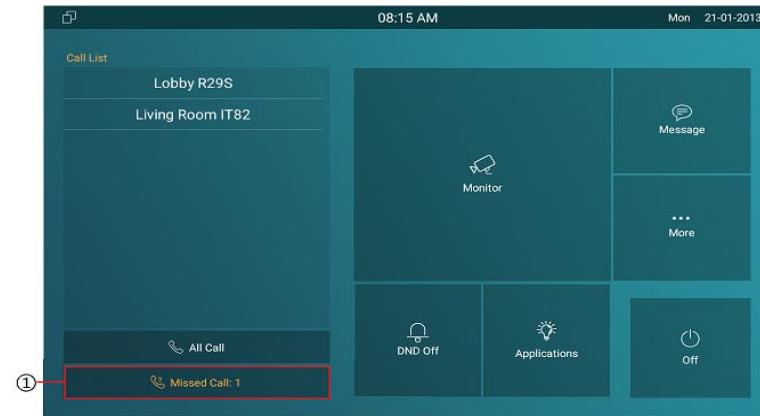

Figure 2.2.3-1 Call from miss call

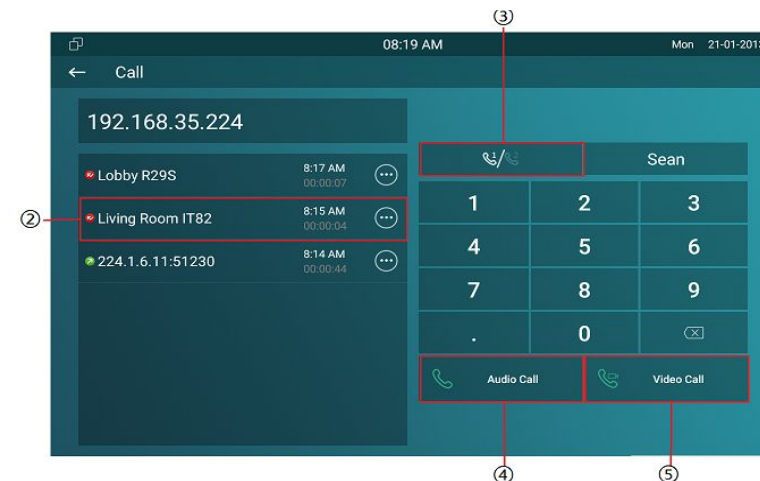

Figure 2.2.3-2 Call from miss call

## 2.2.4. Calling from Device

It will display the devices connected with IT83X on the contact interface. On the device, go to **More - Contact**.

- Click **Update** ① to synchronous the contact automatically.
- Choose a device ② which users want to call.
- Choose **Audio** ③ or **Video** ④ mode to call out.

**Note:** Only under Discovery mode, users need to press **Update** key manually.

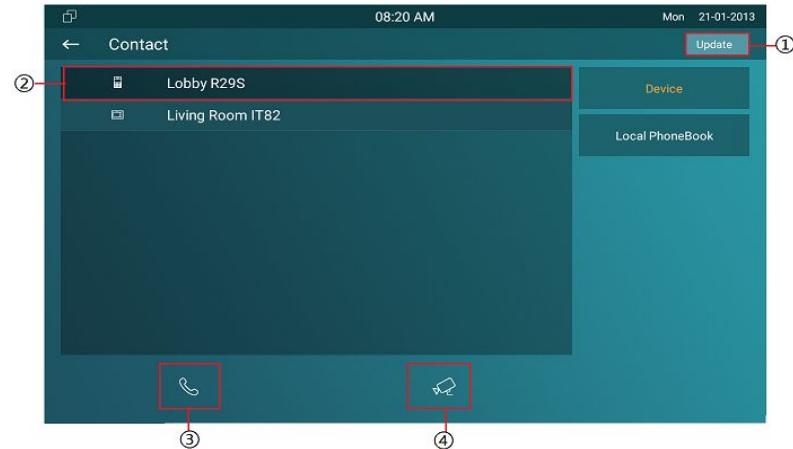

Figure 2.2.4-1 Call from device

## 2.2.5. Calling from LocalPhoneBook

On the device, go to **More - Contact** to enter the **Local PhoneBook** interface to make a call.

- IT83X supports fuzzy matching query ①. To search the list by entering number or alphabet.
- Scroll up or down to select contact ② that users want to call.

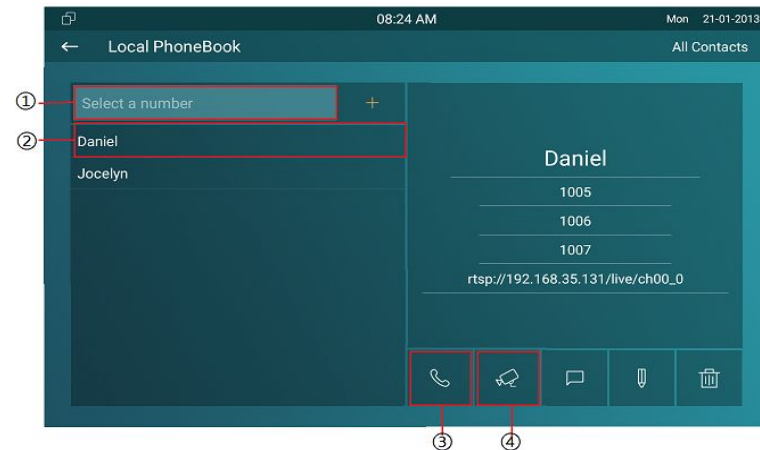

Figure 2.2.5-1 Call from local phonebook



- Choose **Audio** ③ or **Video** ④ mode to call out.

## 2.2.6. Calling from Keypad

On the device, go to **More - Call** to get access to keypad.

- Click account icon ① above the keypad to switch accounts to make a call.
- Input the SIP account /IP address to the keypad ② to call the corresponding devices or soft phone.
- Choose **Audio** ③ or **Video** ④ mode to call out.

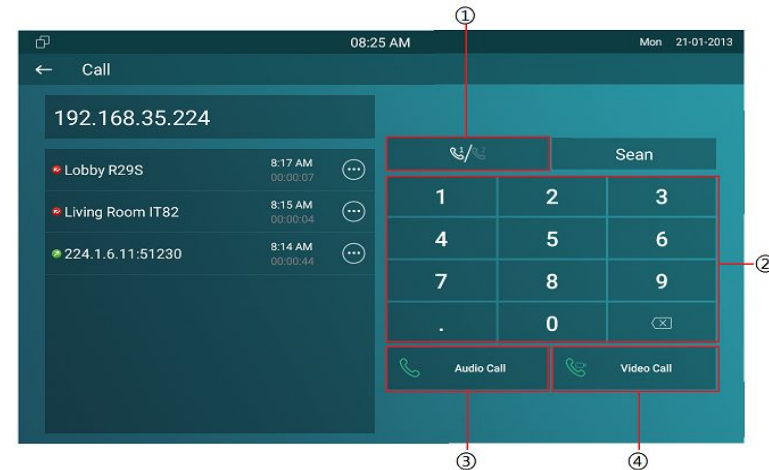

Figure 2.2.6-1 Call from keypad

## 2.3. Receiving a Call

### 2.3.2. Receive an Incoming Call

IT83X supports to preview the caller when it receives an incoming call from door phone.

Tap **Answer** to pick up the incoming call.

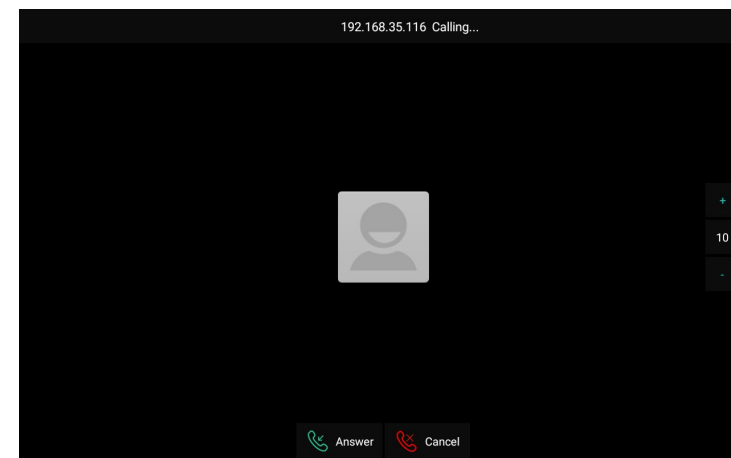

Figure 2.3.1-1 Incoming call

- Tap **Cancel** to reject the incoming call. Press “+” or “-” of the volume on the right side to adjust the ring tone volume.

### 2.3.3. During the session

Tap **Unlock** to open the corresponding door (if the call is from outdoor unit).

Tap **Capture** to take a screen shot of current interface.

- Tap **Mute** to eliminate the voice on IT83X’s side.
- Tap **Switch** to switch from video call to audio call or vice versa.
- Tap **Cancel** to hang up the current call.

## 2.4. Monitor

Monitor feature enables users to view the real-time video from IP cameras or door phones anytime. Click **Monitor** in the home page.

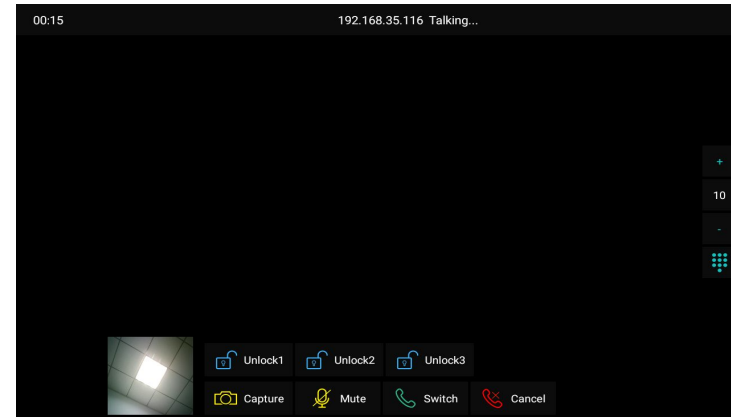

Figure 2.3.2-1 During session

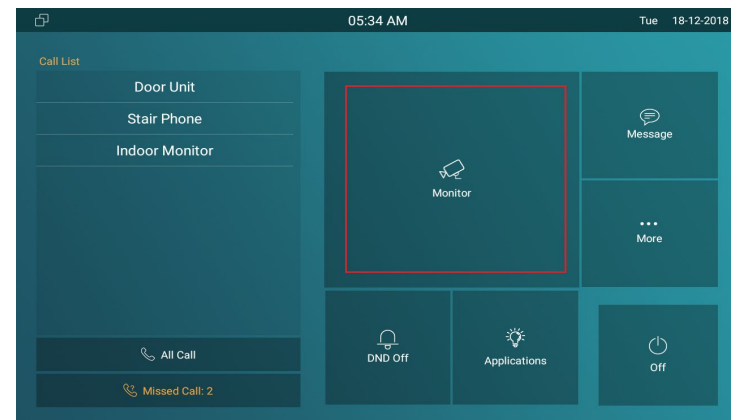

Figure 2.4-1 Monitor

## 2.4.1. Checking the Monitor

Choose the outdoor devices from the list. The real-time video from the door phone or IP camera will show in the screen .

- Press **Unlock** to open the door which is connected with door phone.
- Press **Capture** to take a screen shot of current interface.
- Press **Cancel** to exit the monitoring.
- Press **List button** in the bottom right corner to wake the outdoor video list.
- Press the **Monitor list** in the right side to choose the outdoor videos.

**Note:** Only under Discovery mode, users need to press **Update** key manually to synchronous the devices which is in the same node.

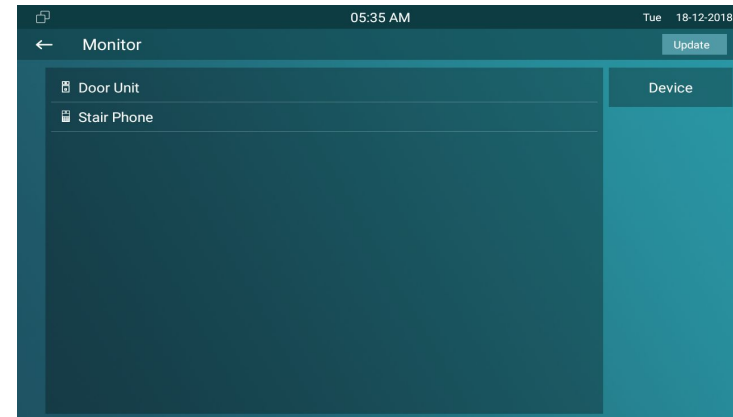

Figure 2.4.1-1 Live view list

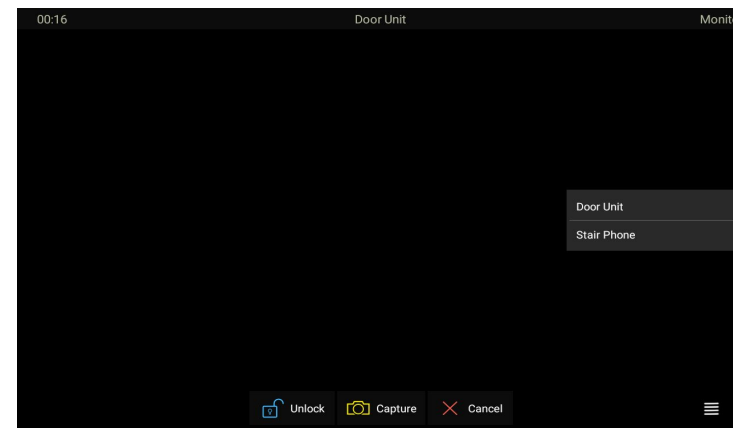

Figure 2.4.1-2 Live view video

## 2.5. Message

**Message** ① indicates how many messages are unread ( An unread message for an example). Or directly enter the message interface to manage.

### 2.5.1. Text Message

- Tap **Message** ① on the main interface to view the unread message.
- Tap the unread message ② to view the message in details.

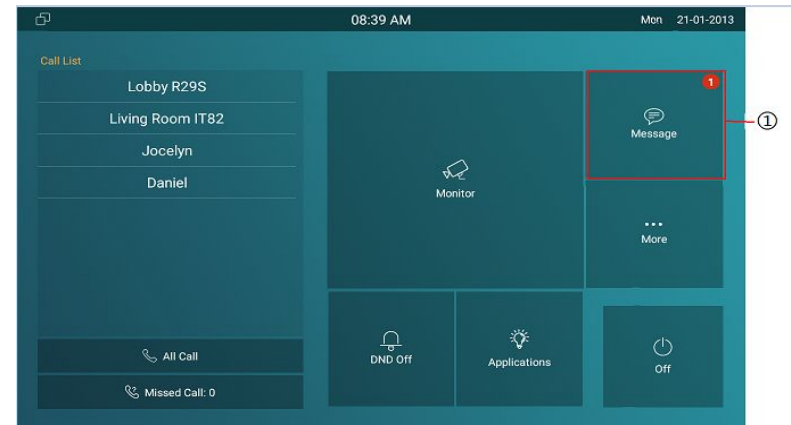

Figure 2.5 -1 Message

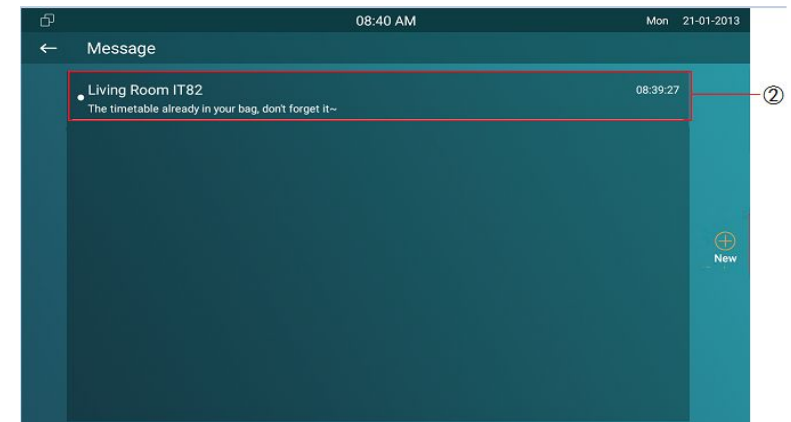

Figure 2.5.1-1 Text message

## 2.5.2. Creating a Message

- Press **New** key ① to create a new message.
- Enter the destination number manually ② or choose the contact from the **contact list** ③ or select the device quickly from the below list ④ .
- Choose the **frequently used message** ⑤ , such as “Hello,” “Help.” Or input the message content which users want to send ⑥.
- Press **Send** key ⑦ to send.

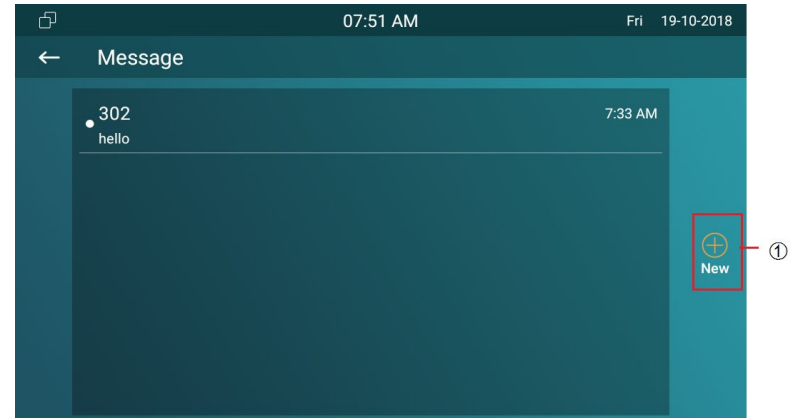

Figure 2.5.2-1 Create message

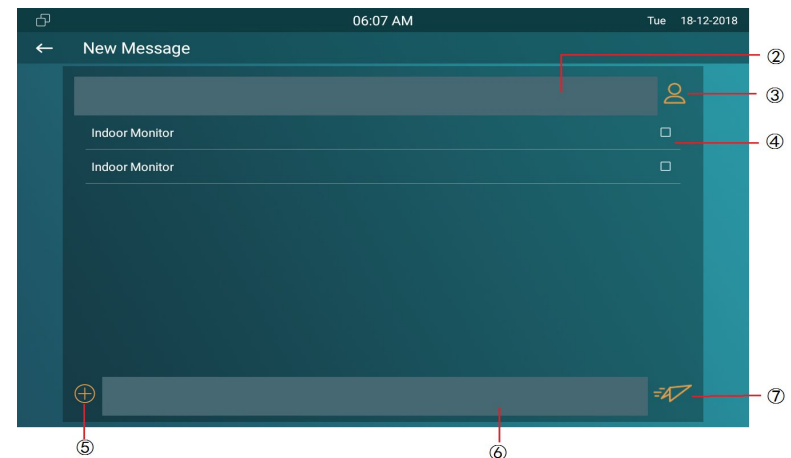

Figure 2.5.2-2 Create message

### 2.5.3. Deleting a Message

- Long press the message ① to select it.
- Click **Select All** ② to select all message in the message lists.
- Click **Delete** ③ to delete the messages have been selected.
- Click **Cancel** ④ to cancel the operation.
- Click **Back** icon ⑤ to exit the message interface.

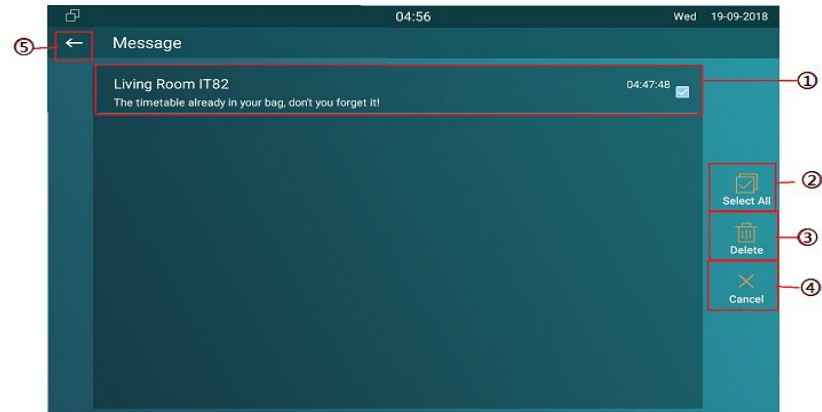

Figure 2.4.2-1 Delete message

## 2.6. Arming

Tap **Arming** to enter the Arming interface. Arming feature is not displayed by default. Users can ask administrator to enable it. Please refer to chapter 3.4.10.

IT83X supports 4 modes, including **Home** mode, **Night** mode, **Away** mode and **Disarmed** mode.

### 2.6.1. Arming Mode

Go to **Arming - Arming mode**. Users can see all of the 8 zones and corresponding sensor types. Slide down to check more information in this interface.

- Adjust **Defence delay time**. It means when users change the arming mode from other modes, there will be 90 seconds delay time to get activated.
- To setup the **Alarm delay**. It means when the sensor triggered, there will be 90 seconds delay time to announce the

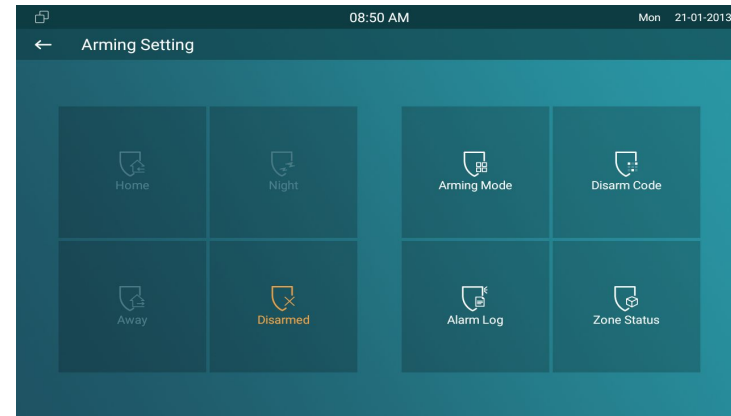

Figure 2.6-1 Arming

The screenshot shows the 'Arming Mode' screen with a table of 8 zones. The table has columns for Zone, Location, Zone Type, Defence delay, Alarm Delay, and Status. The 'Home' mode is selected at the top.

Home		Night		Away	
Zone	Location	Zone Type	Defence delay	Alarm Delay	Status
Zone1	Guest room	Doorbell	90s delay	90s delay	24H
Zone2	Bedroom	Infrared	90s delay	90s delay	Disable
Zone3	Bedroom	Infrared	90s delay	90s delay	Disable
Zone4	Bedroom	Infrared	90s delay	90s delay	Disable
Zone5	Bedroom	Infrared	90s delay	90s delay	Disable
Zone6	Bedroom	Infrared	90s delay	90s delay	Disable
Zone7	Bedroom	Infrared	90s delay	90s delay	Disable
Zone8	Bedroom	Infrared	90s delay	90s delay	Disable

Figure 2.6.1-1 Arming mode

notification.

- The **Status** in the corresponding zone means whether the zone is available or not.
- Press **Save** in the top right corner to save the modification.

## 2.6.2. Disarm Code

Go to **Arming - Disarm Code** to enter the disarm code settings interface. Users can modify the disarm code here.

- Enter the **original disarm code** ① first, and it is 0000 by default.
- Enter the **new disarm code** ②.
- Enter the new disarm code again ③ for confirming.
- Press **Save** to save the modification.

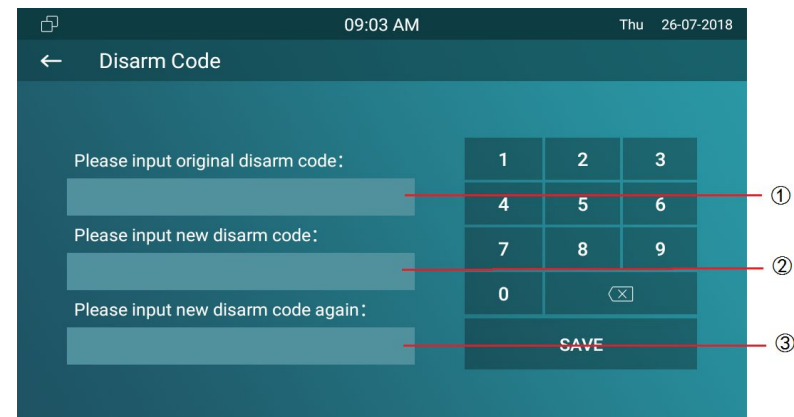

Figure 2.6.2-1 Disarm code



### 2.6.3. Alarm Log

Go to **Arming - Alarm Log** to enter the alarm log interface. Users can check the alarm log, including “location,” “zone,” “zone type” and “alarm time.”

- Hold an **alarm log** ① and it will show up delete prompt.
- Press **Select All** ② to delete all alarm log or select a part of existed messages then click **Delete** ③.
- Press **Cancel** ④ to cancel to deletion.

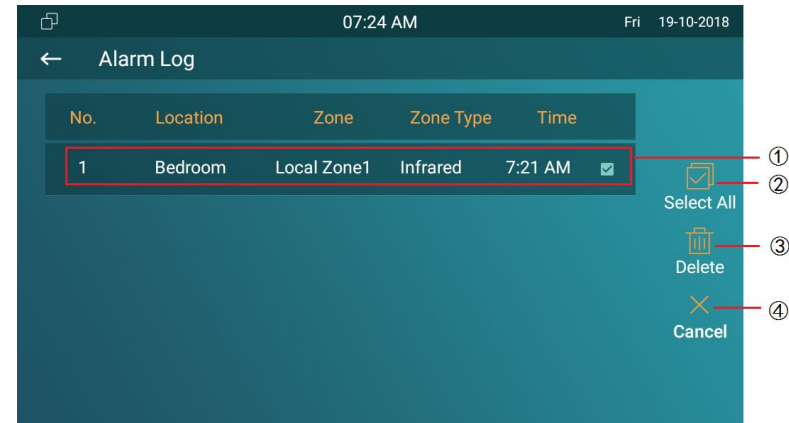

Figure 2.6.3-1 Alarm log

### 2.6.4. Status

Go to **Arming - Zone Status** to enter the zone status interface. Users can check the status of zones, including “location,” “zone type,” “trigger mode” and “status.”

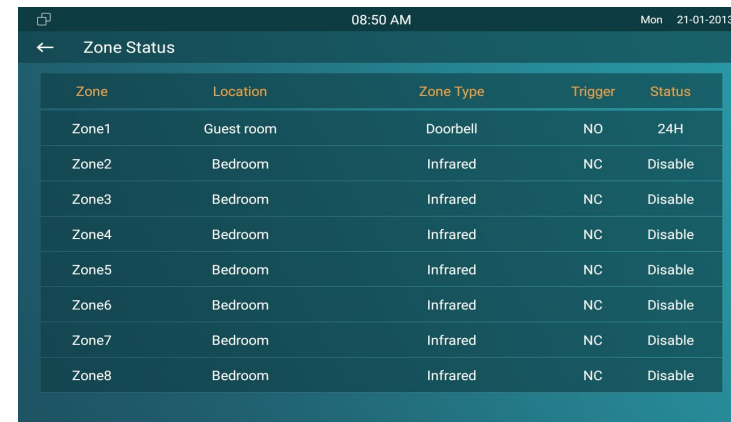

Figure 2.6.4-1 Alarm status

## 3. Basic Features

### 3.1. Accessing the System Settings

#### 3.1.1. Advanced System Setting

On the device, go to **More - Settings - More** (Default password is 123456) to access advanced system settings.

The latter **More** interface have more advanced features' settings.

### 3.2. Accessing the Website Setting

#### 3.2.1. Obtaining IP address

On the device, go to **More - System Info - Network** to check the device's IP address.

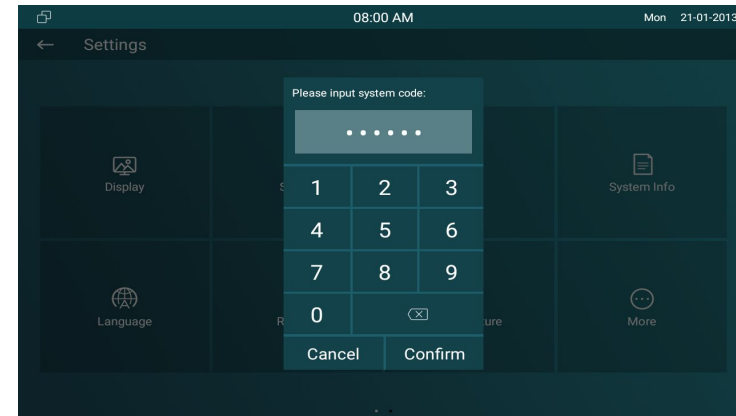

Figure 3.1-1 System setting

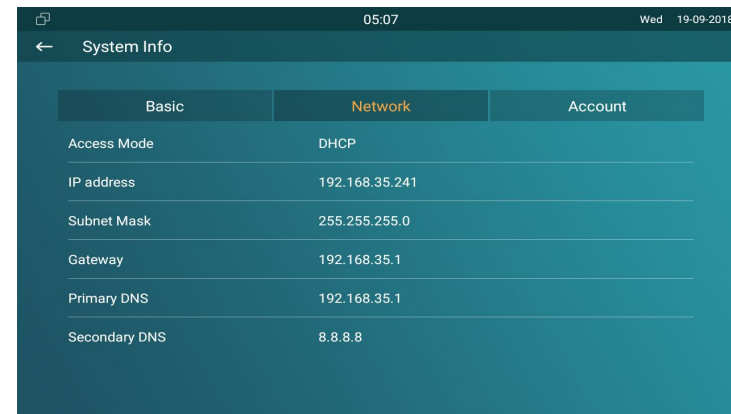

Figure 3.2.2-1 Network status

### 3.2.2. Accessing the Device Website

Type the device's IP address on browser, and input default user name and password: **admin /admin** to access the web interface.

**Note:** The recommended browser is Google Chrome.

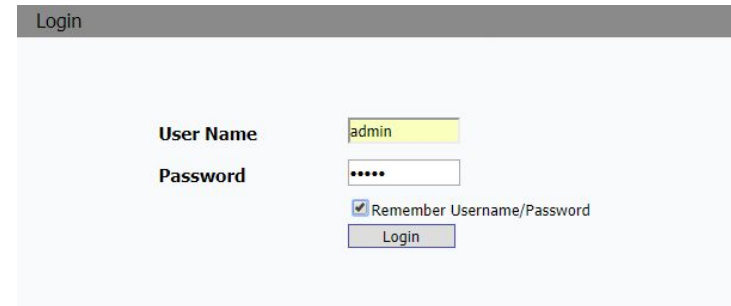

Figure3.2.2-2 Login web

## 3.3. Password Modification

### 3.3.1. System Code Modification

On the device, go to **More - Settings - More - System Code**.

System code is used to enter higher level **More** interface, and the **original system code** ① is 123456. Administrator can edit a **new system code** ② to prevent someone from tampering with the advanced configurations, and then confirm the new one ③ and click submit ④ to save.

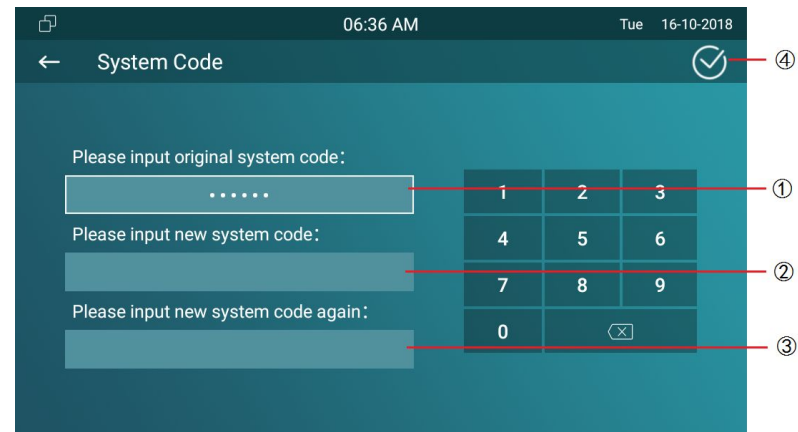

Figure3.3.1-1 System code

### 3.3.2. Setting Code Modification

On the device, go to **More - Settings - More - Setting Code**.

Setting code is used to enter “Setting interface,” and the **original setting code** ① is null. Administrator can edit a **new setting code** ② to prevent someone from entering the setting interface, and then confirm the new one ③ and click submit ④ to save.

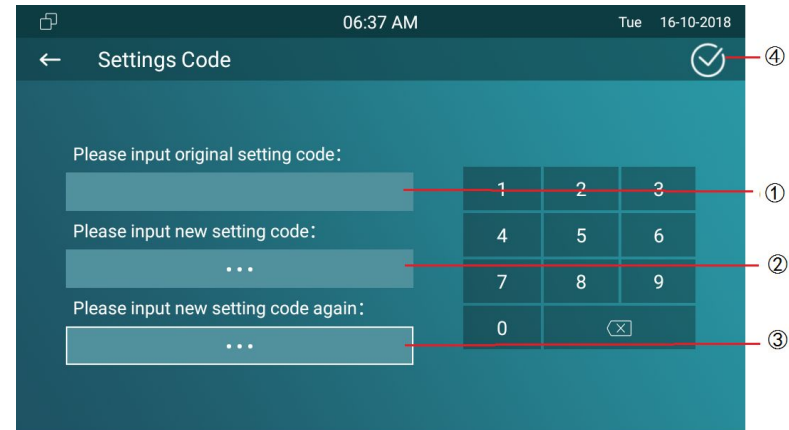

Figure 3.3.2-1 Setting code

### 3.3.3. Web Password Modification

Access the website, go to **Security - Basic** to modify the default website password “admin.” Enter the original password and new password, and confirm the new password again.

**Confirm Password:** To enter the new password again to confirm there is no mistake.



Figure 3.3.3-1 Web Password

## 3.4. Phone Configuration

### 3.4.1. Language

On the device, go to **More - Settings - Language** to choose a suitable phone screen display language, and it is English by default. In the website, go to **Phone - Time/Lang** to select a web language, and it is English by default.



Figure 3.4.1-1 Phone language

### 3.4.2. Time

On the device, go to **More - Settings - Time** to enter the time setting interface.

**Automatic Date Time:** Tick to enable NTP server.

**Set Date:** To set the date manually.

**Set Time:** To set the time manually.

**Time Zone:** To select which time zone user is in.

**Use 24-Hour Format:** To enable 24 hours format for a day.

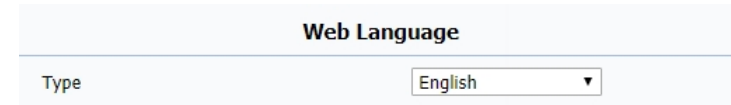

Figure 3.4.1-2 Web language

**Date Format:** To select different date format.

**NTP Server:** To fill in the NTP server to get time automatically.

On the web portal, go to **Phone - Time/Lang**.

**Time Zone:** To select which time zone user is in.

**Primary Server:** To fill in NTP server to get time automatically.

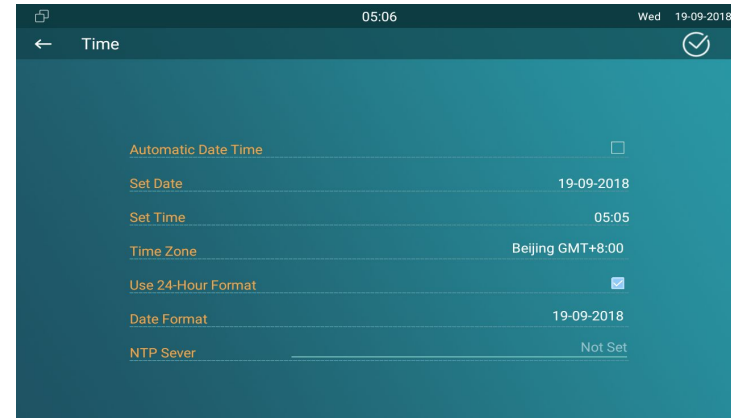

Figure 3.4.2-1 Time setting



Figure 3.4.2-2 NTP setting

### 3.4.3. Network

#### 3.4.3.1. Network Status

On the device, go to **More - System Info - Network**.

Users could check the basic network status from this interface, including access mode, IP address parameters and so on.

On the web portal, go to **Status - Basic - Network Information** to check network information.

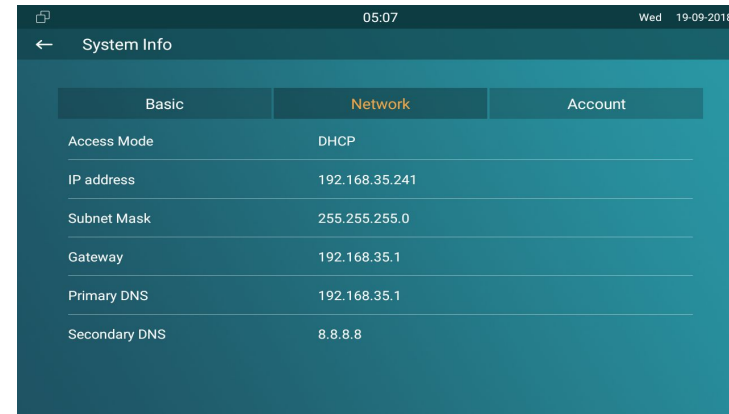

Figure3.4.3.1-1 Network info

Network Information	
LAN Port Type	DHCP Auto
LAN Link Status	Connected
LAN IP Address	192.168.35.30
LAN Subnet Mask	255.255.255.0
LAN Gateway	192.168.35.1
LAN DNS1	192.168.35.1
LAN DNS2	

Figure3.4.3.1-2 Web network info

### 3.4.3.2. Network Settings

On the device, go to **More - Settings - More - Network**.

**DHCP:** Tick the DHCP option to configure the network as DHCP mode, and then IT83X will obtain the IP address, and other network parameters automatically.

**Static IP:** Fill in the parameters of LAN IP, subnet mask, gateway, pri DNS server and sec DNS server manually.

On the web portal, go to **Network - Basic** to configure the network settings.

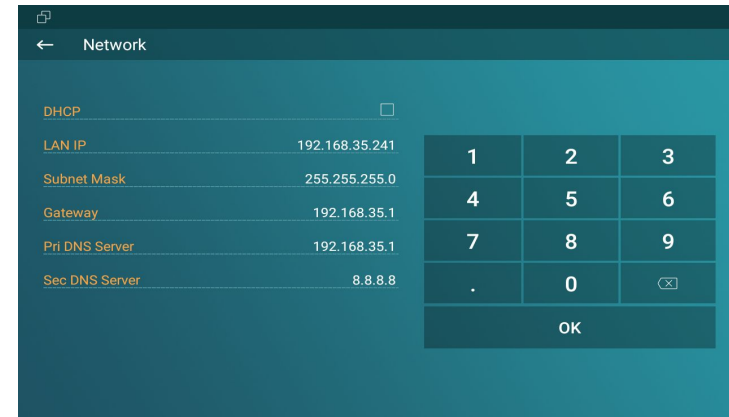

Figure 3.4.3.2-1 Wire network setting

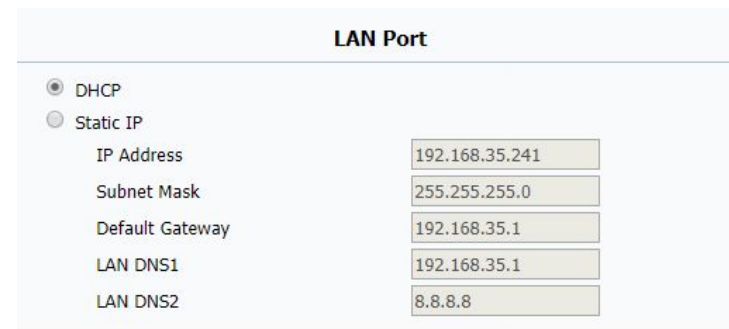

Figure 3.4.3.2-2 Wire network setting



### 3.4.3.3. WiFi Setting (optional)

On the device, go to **More - Settings - More - WiFi** to enable the WiFi feature, choose the suitable AP (Access point), and then enter the password to connect to it.

### 3.4.3.4. Local RTP

On the web portal, go to **Network - Advanced - Local RTP**.

**Starting RTP Port:** To determine the minimum port for RTP stream.

**Max RTP Port:** To determine the maximum port for RTP stream.

### 3.4.4. Display Settings

On the device, go to **More - Settings - Display**.

**Brightness:** To adjust the brightness which is 145 by default. The range is from 0 to 255. The bigger value means the brighter screen.

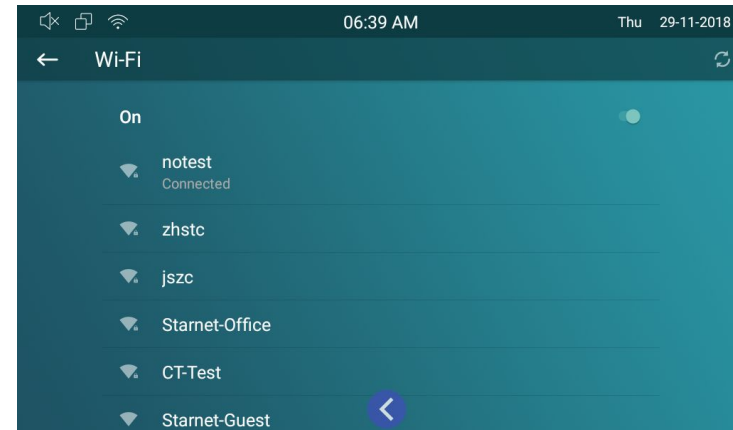

Figure 3.4.3.3-1 Wireless network

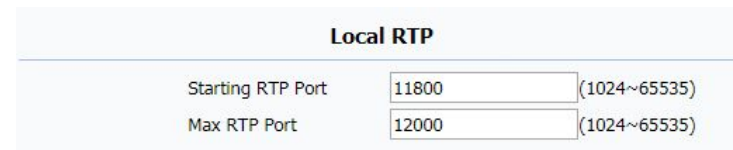

Figure 3.4.3.3-1 RTP setting

**Sleep:** To configure the sleep delay which is 1 minute by default. If there is no any operation in 1 minute, it will turn to sleep screen.

**Screen Saver Lock Time:** To configure the time to make it display sleep screen when it is in screen savor mode.

**Screen Saver:** To enable screen saver mode.

**Screen Lock:** To enable the lock of screen, the device will be unlocked over the sleep time. Users are required the face recognition (Face ID) or password to wake up IT83X.

**Screen Clean:** Press screen clean to clean the screen, and it will keep users from misusing.

**Font Size:** To adjust the size of words which is displayed on the screen.

### 3.4.5. Sound Settings

On the device, go to **More - Settings - Sound**.

**Ring Volume:** To set ring volume for incoming calls.

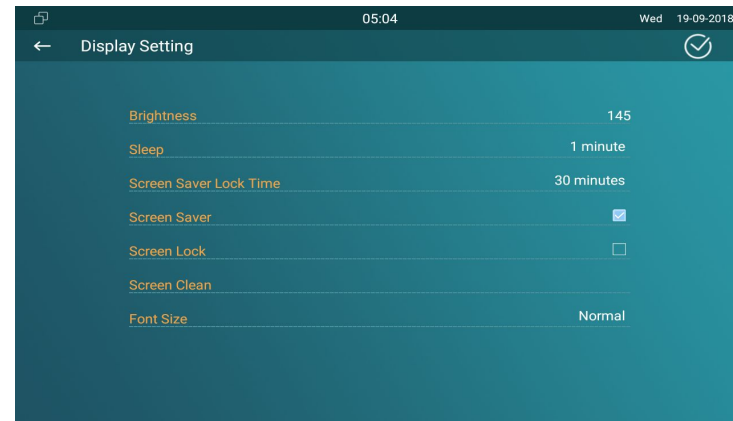

Figure 3.4.4-1 Display setting

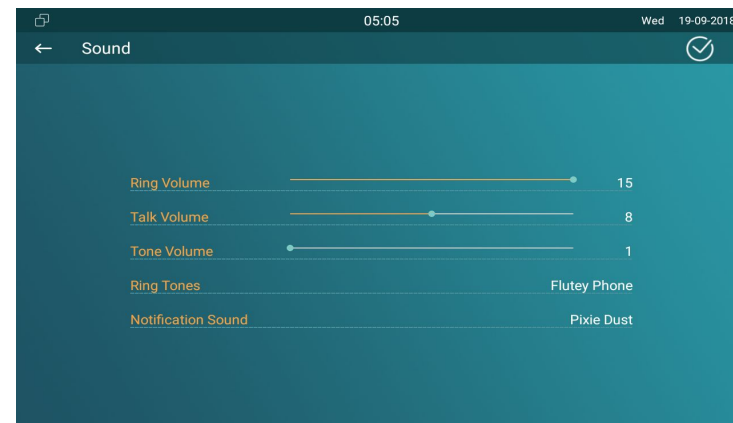

Figure 3.4.5-1 Sound setting

**Talk Volume:** To set talk volume during the call.

**Tone Volume:** To set tone volume.

**Ring Tones:** To set different ring tones for incoming call.

**Notification Sound:** To set notification sound when receiving message.

### 3.4.6. Door Bell Sound

On the web portal, go to **Phone - Audio**.

**Upload:** To choose the suitable sound file from the local folder.  
Click Import to save. Please note the tip about the sound file format.

**Sound File:** Choose one sound file from imported sound files before.



The screenshot shows a web interface titled "Doorbell Sound". It features two main sections. The first section, labeled "Upload(.wav/.mp3)", contains a "Choose file" button, a "No file chosen" status indicator, and "Import" and "Cancel" buttons. The second section, labeled "Sound File", contains a dropdown menu and a "Delete" button.

Figure 3.4.6-1 Doorbell sound

### 3.4.7. DND

The full name of DND is Do Not Disturb. It allows IT83X to ignore any incoming calls.

- On the device home screen, tap the **DND** to able or disable DND function.

On the web portal, go to **Phone - Call feature - DND**.

**DND:** Enable or disable this function.

**Return Code When DND:** To configure the return code to caller when rejecting the call.

**DND On Code:** The code is used to turn on DND on server's side, if configured, IT83X will send a SIP message to server to turn on DND on server side if users press DND when DND is off.

**DND Off Code:** The code is used to turn off DND on server's side, if configured, IT83X will send a SIP message to server to turn off DND on server side if users press DND when DND is on.

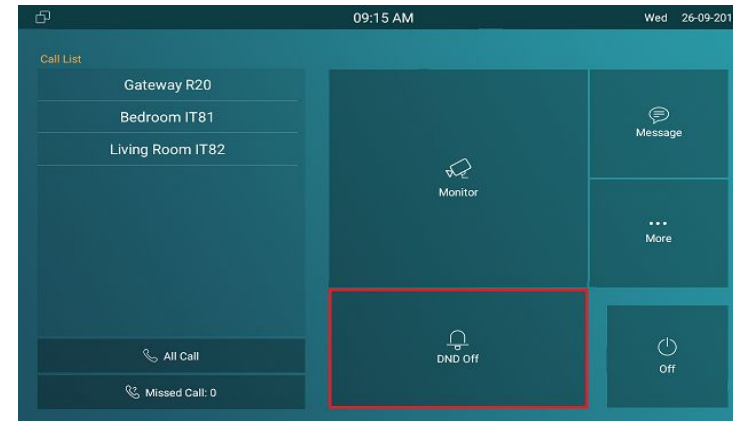

Figure 3.4.7-1 DND switch

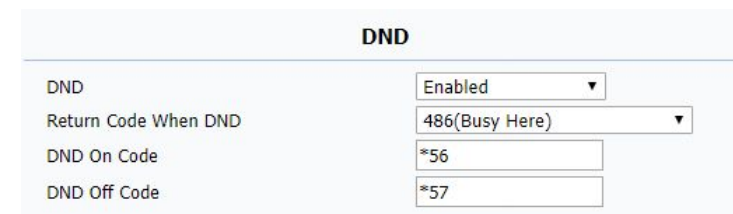

Figure 3.4.7-2 DND setting

### 3.4.8. Capture

On the device, go to **More - Settings - Call Feature**.

IT83X will automatically take a screenshot from the visitor during the talking, or users can tap the **Capture** key during the live view or calling manually and the capture will be saved in the default path.

Users can change the default path by themselves.

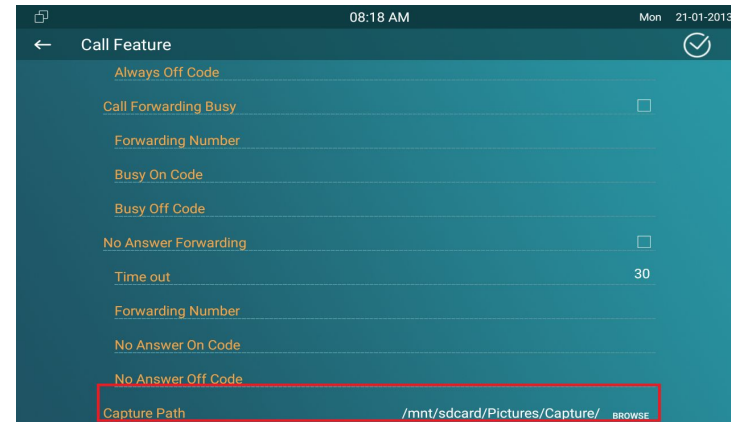

Figure 3.4.8-1 Capture path

### 3.4.9. Logo

On the web portal, go to **Phone - Logo**.

Users are able to upload the logo picture, IT83X will display the logo when powering up.

Click **Reset** to reset the boot logo to original one.



Figure 3.4.9-1 Boot logo

### 3.4.10. Key Set of IT83X Monitor

On the web portal, go to **Phone - Key/Display**. Users can customize the feature icon display, to choose which feature will be shown and where it will be displayed.

**Type:** To select which function shall be displayed on the home page or more page. “DND” and “Message” are displayed on home page, “Call,” “Contact,” “Settings” and “Status” are displayed on more interface by default.

**Value:** To fill in corresponding parameters for some types. For example, if users want to display a third party APP on the home screen, the type shall be chosen as “Custom APK” and fill in the value with corresponding package name and class name.

**Example:** To view the display example of IT83X on home page interface or more interface.

Home Page Display <a href="#">Example</a>		
Area	Type	Value
Area 1	DND	
Area 2	Message	

More Page Display <a href="#">Example</a>		
Area	Type	Value
Area 1	Call	
Area 2	Contact	
Area 3	Settings	
Area 4	DND	
Area 5	Arming	
Area 6	SOS	
Area 7	Motion Detector	
Area 8	Custom APK	

Figure 3.4.10-1 Icon display

## 3.5. Local PhoneBook

### 3.5.1. Adding a Contact

On the device, go to **More - Contacts - LocalPhoneBook**.

- Enter Contact interface, and then press **+** symbol ① to add new contact.
- Type in new contact name ② .
- Click **Number 1/2/3** ③ to enter number 1/2/3, which could be SIP number or IP number. It is supported 3 numbers for each of the contact person.
- Click **CameraUrl** ④ to enter RTSP URL of outdoor unit.

**Note:** The RTSP URL of Akuvox door phone is `rtsp://device_IP/live/ch00_0`.

- Tap **Cancel** ⑥ to cancel the operation or press **Confirm** ⑤ to make changes to the contact setting.

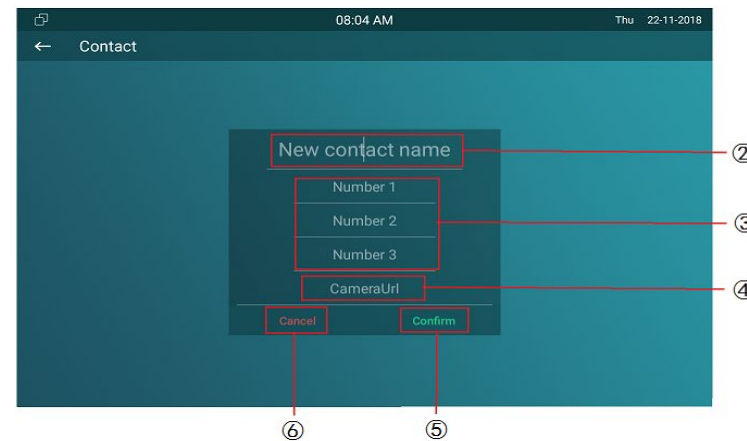
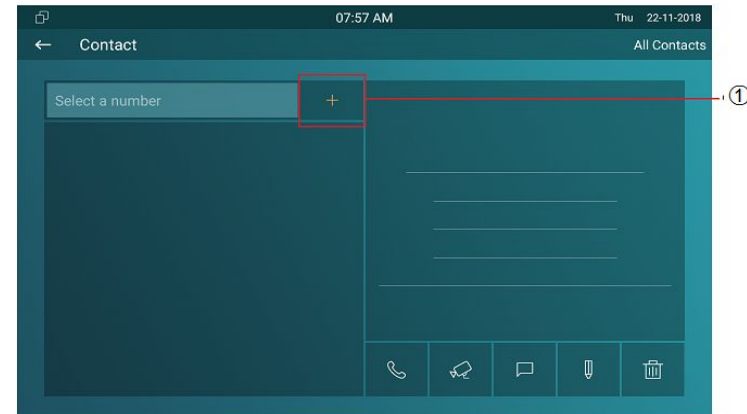

### 3.5.2. Editing a Contact

On the device, go to **More - Contacts - Local PhoneBook** to enter contact interface, and select one existed contact.

- Press **Edit** icon ① to modify the existed contact.
- Press **Delete** icon ② to delete a existed contact.

On the web portal **PhoneBook - Local Book**, users can also do some modification about contact.

**Contact:** To display all contact or black list.

**Search:** To search the contact by entering number or name.

**Dial:** To dial out the number that users have filled in.

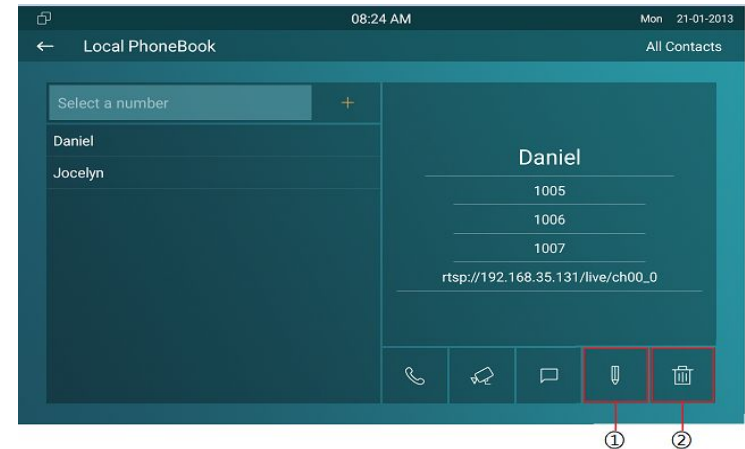

Figure 3.5.2-1 Editing a contact

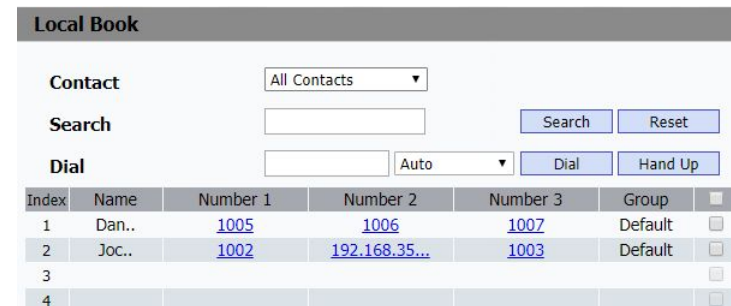

Figure 3.5.2-2 Web contact



### 3.5.3. Contact Import/Export

**Import/Export:** To import or export the contacts in bulk, please make sure the format is correct.



Figure 3.5.3-1 Import/Export contact

### 3.5.4. Black List

On the device, go to **More - Contact - LocalPhoneBook - Black List**.

- Click **All Contacts** ① to switch the local phone book from all contacts to black list or vice versa.
- Press **+** ② to add number into black list.
- Click phone book icon ③ to view the existing contacts in local phone book.
- Tap contacts ④ to select the corresponding contact person into black list.
- Tap **Select All** ⑤ to select all contacts.

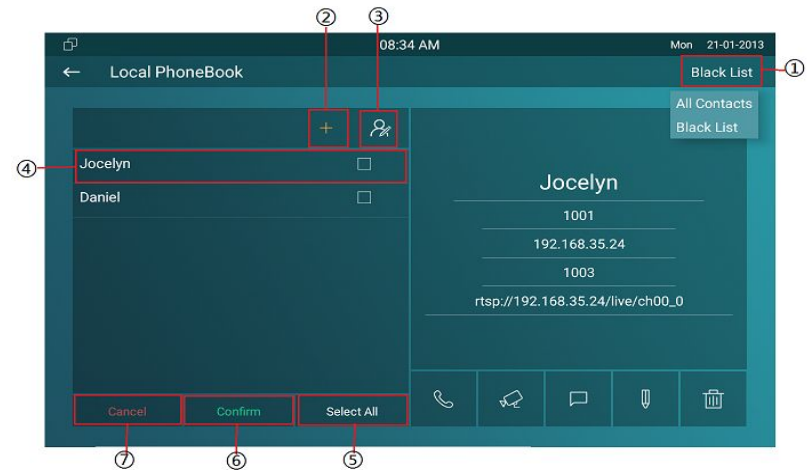

Figure 3.5.4-1 Black list

- Tap **Confirm** ⑥ to add contacts into black list.
- Tap **Cancel** ⑦ to cancel the operation.

On the web portal, **PhoneBook - Local Book - Contact - Blacklist.**

User can also do some configurations.

**Contact:** To display black list or all contact.

**Search:** To search the contact by entering number or name.

**Dial:** To dial out the number that users have filled in.

**BlackList Setting:** To add new contact to black list.

Index	Name	Number 1	Number 2	Number 3	
1	Joc..	1002	192.168.35...	1003	<input type="checkbox"/>
2					<input type="checkbox"/>
3					<input type="checkbox"/>
4					<input type="checkbox"/>
5					<input type="checkbox"/>
6					<input type="checkbox"/>
7					<input type="checkbox"/>
8					<input type="checkbox"/>
9					<input type="checkbox"/>
10					<input type="checkbox"/>

Figure 3.5.4-2 Blacklist in web

**BlackList Setting**

Name:

Number 1:

Number 2:

Number 3:

Figure 3.5.4-3 Add blacklist

## 3.6. Intercom Call

### 3.6.1. IP Direct Call

Without sip server, users can also use IP address to call each other, but this way is only suitable in the LAN.

On the web portal, go to **Phone - Call Feature - Others - Direct IP** to enable the direct IP function.

Enter the IP address of the caller, and then press **Audio Call** or **Video Call** to make a call.

### 3.6.2. SIP Call

Sip call uses sip number to call each other which should be supported by sip server. Users need to register an account and fill some sip feature parameters before using it.

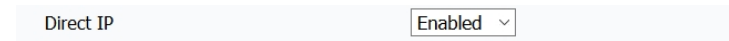

Figure 3.6.1-1 IP call switch

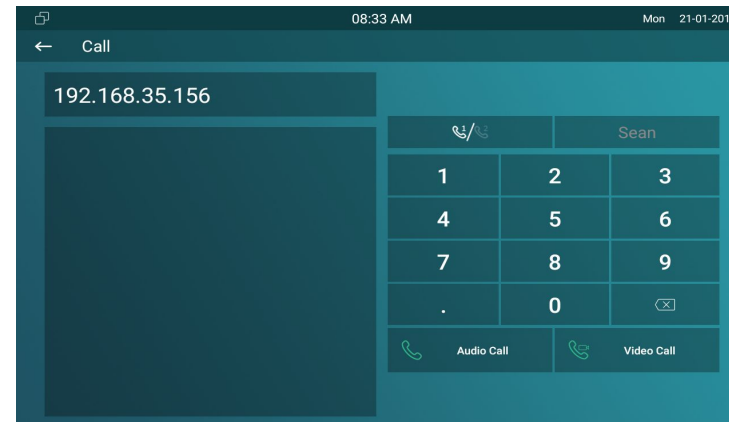

Figure 3.6.1-2 Direct IP call

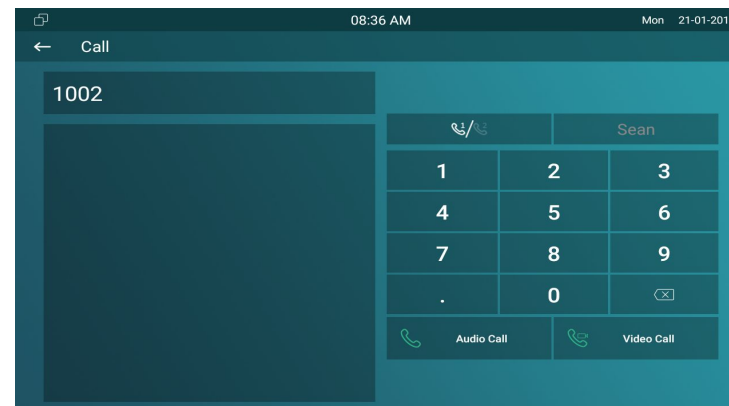

Figure 3.6.2-1 SIP call

### 3.6.3. Account Status

On the device, go to **More - System Info - Account**.

Users could check the basic SIP account status here, registered means it is ready for using.

On the web portal, go to **Status - Account** information to check the basic information of SIP account.

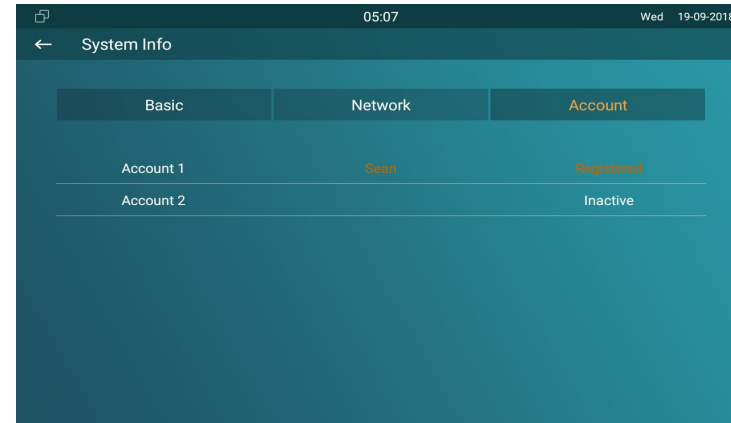

Figure 3.6.3-1 Account status

Account Information	
Account1	1004@192.168.35.230 Registered
Account2	None@None Disabled

Figure 3.6.3-2 Account info

### 3.6.4. SIP Account

On the device, go to **More - Settings - More - Account**.

**Active:** To activate SIP account.

**Label:** To enter the label name of this account, which will show on the account status interface.

**Display Name:** To enter the display name of this account, which will show on other devices when making calls.

**Register Name:** To enter the number registered onto SIP server.

**User Name:** To enter the extension number registered onto SIP server.

**Password:** To enter the password of the corresponding users.

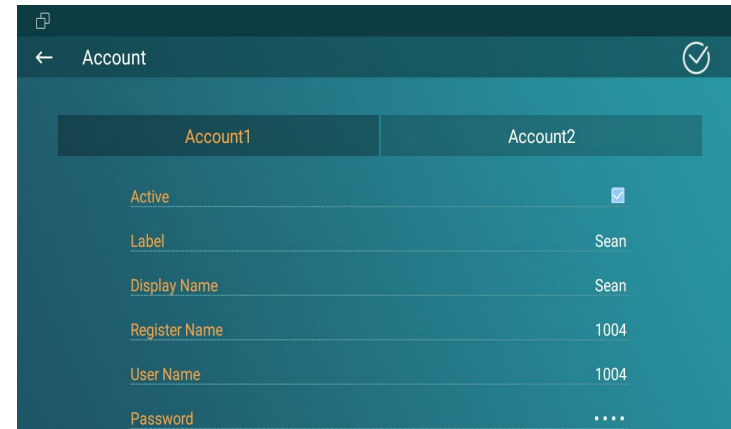

Figure 3.6.4-1 SIP account

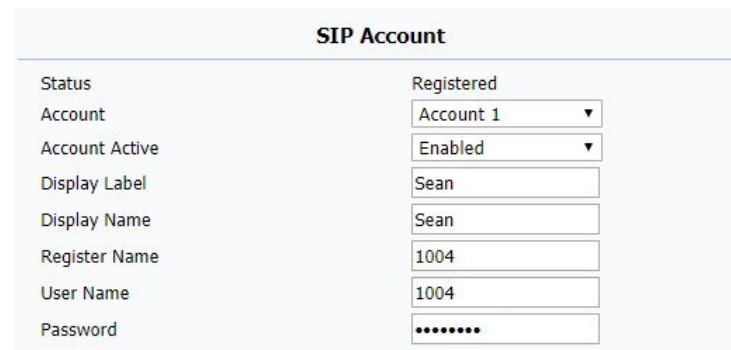

Figure 3.6.4-2 Web SIP account

### 3.6.5. SIP Server

Enter the SIP account address which points to the sip server.

**Server IP:** To enter SIP server's IP address or URL.

**Port:** The specified port number for the sip server.

**Registration Period:** The registration will expire after registration period, and IT83X will re-register automatically within registration period.

On the web portal, go to **Account - Basic** to check the information of SIP account in details.

### 3.6.6. Outbound Proxy Server

On the web portal, go to **Account - Basic** to setup outbound proxy server.

**Outbound Proxy Server:** To configure the proxy server to receive all initiating request messages and route them to the designated SIP server.

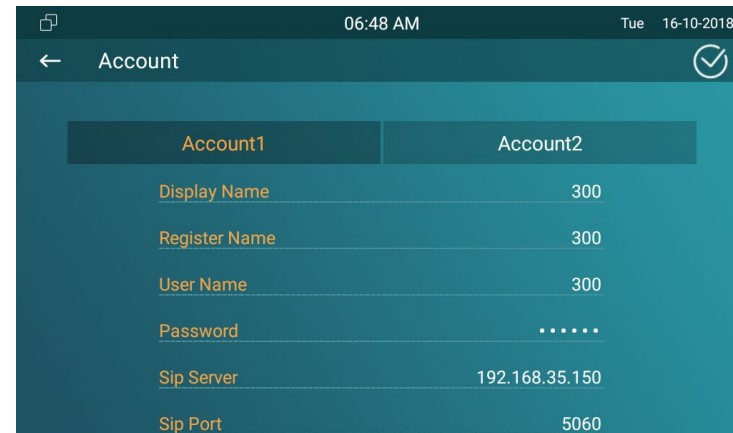

Figure 3.6.5-1 SIP server

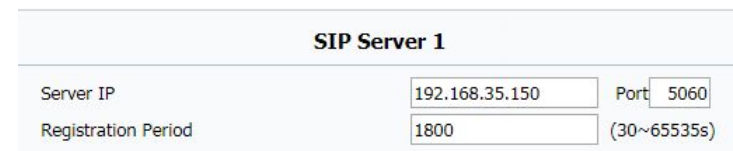

Figure 3.6.5-2 SIP server

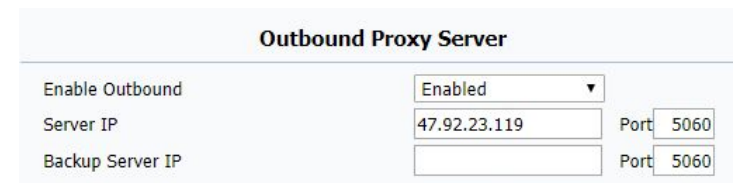

Figure 3.6.6-1 Outbound server

### 3.6.7. Transport Type

On the web portal, go to **Account - Basic** to setup transport type.

- UDP: UDP is an unreliable but very efficient transport layer protocol.
- TCP: Reliable but less-efficient transport layer protocol.
- TLS: Secured and reliable transport layer protocol.
- DNS-SRV: DNS record for specifying the location of services

### 3.6.8. Auto answer

On the web portal, go to **Account - Advanced** to enable /disable auto answer feature. It will auto answer all incoming calls if it is enabled.

**Note:** Auto answer is only available with SIP accounts.

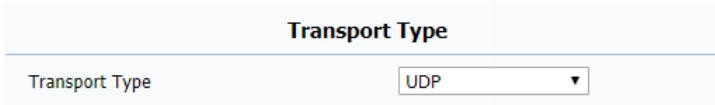

Transport Type	
Transport Type	UDP

Figure 3.6.7-1 Transport type

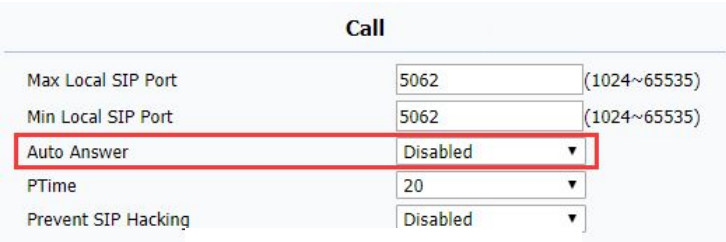

Call	
Max Local SIP Port	5062 (1024~65535)
Min Local SIP Port	5062 (1024~65535)
Auto Answer	Disabled
PTime	20
Prevent SIP Hacking	Disabled

Figure 3.6.8-1 Auto answer switch

On the web portal, go to **Phone - Call Feature** to setup auto answer whitelist. It will auto answer the incoming calls when the caller is in white list.

**Device Location:** To enter the device name /location.

**SIP/IP:** To enter the SIP /IP number of the corresponding devices.

**Auto Answer WhiteList:** To display the SIP /IP number stored in IT83X's white list.

**Note:** White list takes effect both SIP account and IP address.

### 3.6.9. Assistance call

Assistance call is used to call out the emergency numbers in loop times when users need help. Users could choose to display SOS on the home /more page, please refer to chapter 3.4.10 about the feature display setting.

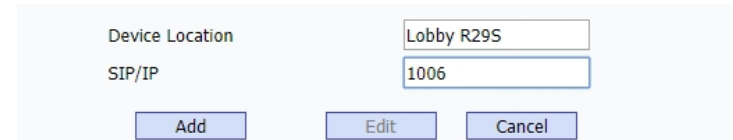
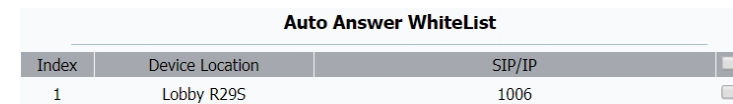

Figure 3.6.8-2 Whitelist setting



Index	Device Location	SIP/IP
1	Lobby R29S	1006

Figure 3.6.8-3 Whitelist setting display

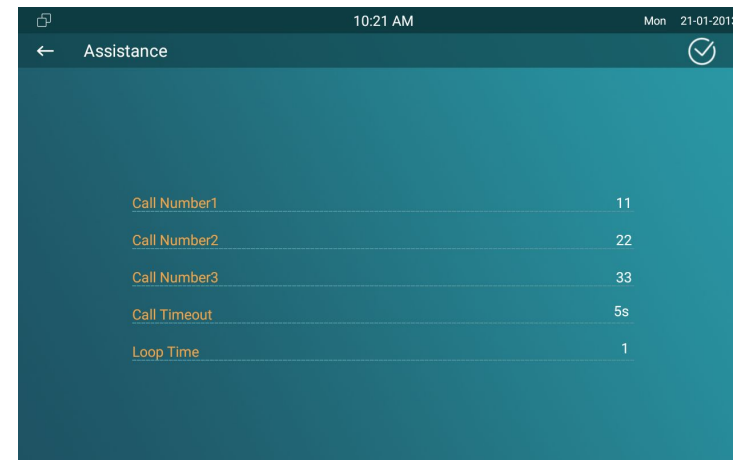

Figure 3.6.9-1 SOS call



**Call Number:** To setup 3 SOS numbers. Once users press SOS key on the home page (SOS display key shall be set on the web manually), IT83X will call out the number in order.

**Call Timeout:** Setup the timeout for each number. Once users call out, if the other side will not answer within the timeout, IT83X will continue to call the next number.

**Loop Times:** To setup the call loop times.

### 3.6.10. Multicast

Multicast function could only be applied among indoor monitors. After configuration on the web portal, users could tap **All Call** on the home page of the device to make a call.

On the web portal, go to **Phone - Multicast**.

**Multicast Setting:** To set the IT83X in one of the groups or disable this function.

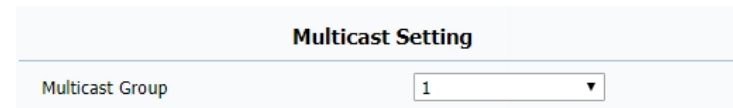

The screenshot shows a web form titled "Multicast Setting". It contains a single dropdown menu labeled "Multicast Group" with the value "1" selected.

Figure 3.6.10-1 Multicast group

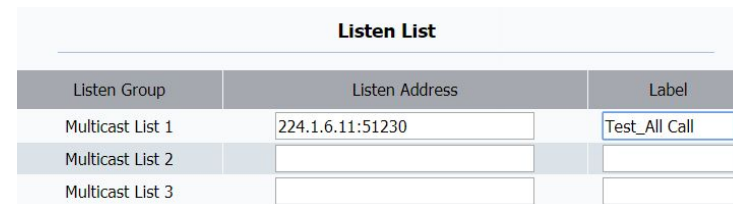

The screenshot shows a table titled "Listen List" with three columns: "Listen Group", "Listen Address", and "Label".

Listen Group	Listen Address	Label
Multicast List 1	224.1.6.11:51230	Test_All Call
Multicast List 2		
Multicast List 3		

Figure 3.6.10-2 Multicast address setting

**Multicast List:** To fill in the parameters of multicast group. IT83X will establish multicast calls to other indoor monitors which are set in multicast group.

**Listen List:** To fill in the parameters of listen group. IT83X will receive multicast calls if some indoor monitors call the listen group.

**Label:** To show the label name on the calling interface if users establish all call.

## 3.7. Security

### 3.7.1. Monitor Settings

Monitor will help users to check real-time video of the surrounding environment of house. In the device, go to **More - Settings - More - Monitor**.

**Number:** To enter the IP address/SIP number of the corresponding camera. Enter the RTSP or ONVIF URL of the door phone or IP camera.

Multicast List	
Multicast Group	Multicast Address
Multicast Group 1	224.1.6.11:51230
Multicast Group 2	224.1.6.11:51231
Multicast Group 3	224.1.6.11:51232

Figure 3.6.10-3 Multicast group

The screenshot shows a mobile application interface for 'Monitor' settings. It features a dark teal background with white text and input fields. The fields are: 'Number' with the value '1006', 'Doorphone ID' with '001', 'RTSP Address' with 'rtsp://192.168.35.131/live/ch00\_0', 'User Name' with 'admin', and 'Password' with masked characters '.....'. A back arrow is on the top left and a checkmark is on the top right.

Figure 3.7.1-1 Live view

**Doorphone ID/Device Name:** To enter the ID number of doorphone, which could be set by users.

**RTSP Address/Destination URL:** To set the RTSP URL for the door phone. The RTSP format of Akuvox door phone is **rtsp://device IP/live/ch00\_0**.

**User Name:** To enter the user name if required.

**Password:** To enter the password if required.

On the web portal **Phone - Monitor**, users can also setup the monitor information.

Index	Number	Name	URL	User Name	
1	1007	Gateway R26	rtsp://192.168.35.121/live/ch00_0	admin	

Figure 3.7.1-2 Live view in web

## 3.8. Access control

### 3.8.1. Face ID

On the device, go to **More - Settings - More - Face ID** to setup face ID to access to IT83X, which provides setting security.

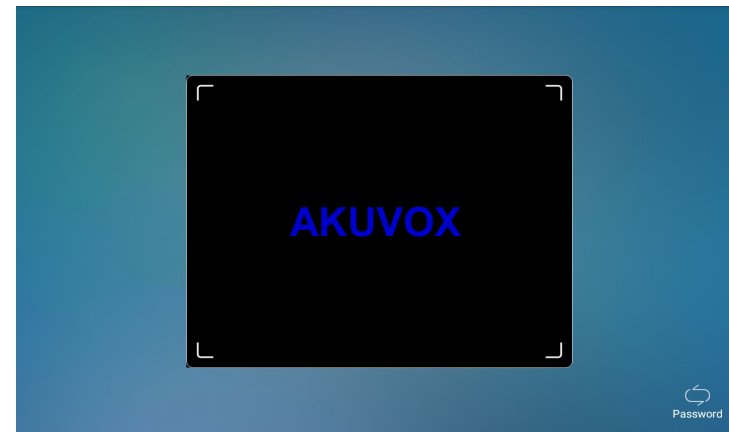

Figure 3.9.2-1 Face ID

- To implement face ID feature on IT83X, the **Screen Lock** on display setting interface should be enabled first.
- The whole process is actually self-explanatory, follow the indication to record users' face ID to IT83X.
- When screen lock is enabled, users could choose face ID or password (System code) to enter IT83X.

### 3.8.2. Local Relay

IT83X has NO/NC/COM three terminals which supports to connect locks by itself.

Go to **Phone - Relay** to setup the DTMF code of local relay in website. Users can press the **Unlock** key during the call.

**Relay Delay:** To set the delay time for local relay.

**Status:** To enable or disable the softkey in talking page.

**Display Name:** To modify the display name of unlock icons in talking page.

The screenshot shows a 'Relay Setting' page with two sections: 'Local Relay1' and 'Local Relay2'. Each section has a 'Relay Delay(sec)' label and a dropdown menu currently set to '3'.

Figure 3.8.2-1 Local relay setting

The screenshot shows a 'Softkey In Talking Page' table with four columns: Key, Status, Display Name, and Relay. The table contains three rows of data.

Key	Status	Display Name	Relay
Key 0	Enabled	Unlock1	Local Relay 1
Key 1	Enabled	Unlock2	Local Relay 2
Key 2	Enabled	Unlock3	Remote Relay DTMF

Figure 3.8.2-2 Relay display

**Relay:** To set the relay type, including local relay 1/2, remote relay HTTP and remote relay DTMF.

### 3.8.3. Remote relay

IT83X can use the unlock key during the call to open the door in doorphone's site. Users need to setup the same DTMF code in the door phone and indoor monitor.

**Remote Relay:** To set DTMF code for remote relay, which is “#” by default.

### 3.8.4. Reboot

On the device, go to **More - Settings - Reboot**.

- Click the **Reboot** icon to reboot the device.

One the web portal **Upgrade - Basic - Reboot**, users can also reboot the device.

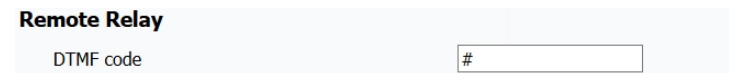

Figure 3.8.3-1 Remote relay setting

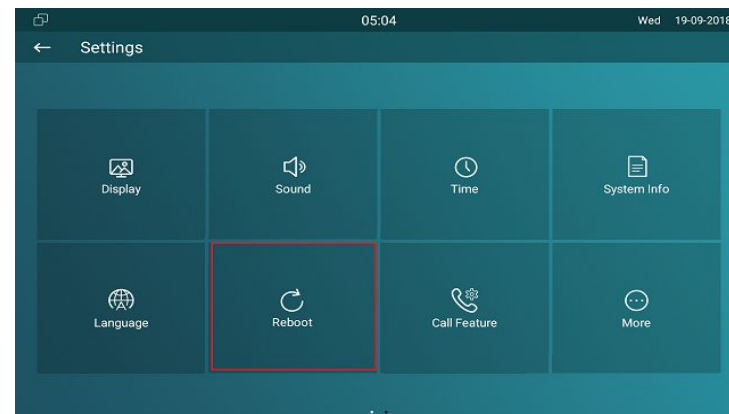

Figure 3.8.4-1 Reboot

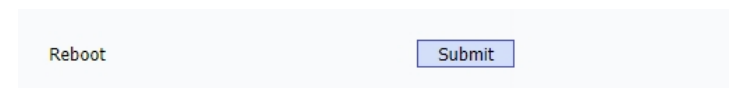

Figure 3.8.4-2 Web reboot

### 3.8.5. Reset

On the device, go to **More - Settings - More**.

**Reset To Factory Setting:** Reset all data to factory settings.

**Reset Config To Factory Setting:** Reset all configurations (in the directory /data/data/config) which only be used by IT83X to factory settings. But like 3rd party application which users installed, contacts which users added, such kind of data will not be reset.

On the web portal **Upgrade - Basic**, users can also store the device.

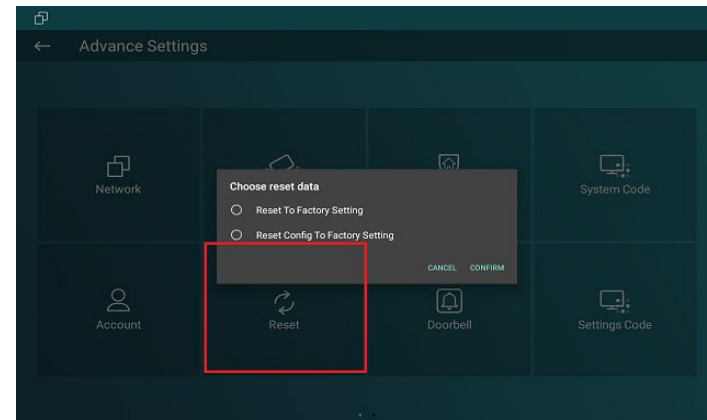

Figure 3.8.5-1 Reset



Figure 3.8.5-2 Web reboot

## 4. Advanced Features

### 4.1. Phone Configuration

#### 4.1.1. Installing Custom APK

Users could choose to display **Custom APK** (The 3rd party Android app) on the home/more page, which provides users easier access to their own application. On the web portal, go to **Upgrade - Key/Display**.

**Package Name:** To fill in the package name of APK (For example: com.akuvox.mobile.smartplus).

**APP Class Name:** To fill in the class name of APK (For example: com.akuvox.mobile.module.main.view.SplashActivity).

**Start Up Enable:** To choose whether APK should start up automatically when power up.



The screenshot shows a configuration form titled "Third Party APK Control". It contains the following fields and options:

Third Party APK Control	
Package Name	<input type="text"/>
APP Class Name	<input type="text"/>
Start Up Enable	Disabled ▼
Turn Back Apk Enable	Disabled ▼
Intervals Without Operating	10 ▼ (s)
Show App Icon	Enabled ▼

Figure 4.1.1-1 Install APK

**Turn Back Apk Enable:** To choose whether turn back APK without operating for some interval.

**Intervals Without Operating:** To choose how much time to turn back APK without operating.

**Show App Icon:** To choose whether to show APP icon on the home interface or not.

## 4.1.2. Discovery setting

If **Discovery** mode is adopted, users don't need to configure the devices by themselves. IT83X will scan automatically all types of the devices on the same discovery node.

On the device, go to **More - Settings - More** to configure the discovery mode and location name. **Discovery Node/Device Address:** To indicate the locations of the device (For example, device address 1.1.1.1.1 means that this device is located in Community 1, Building 1, Unit 1, Floor 1, Room 1).

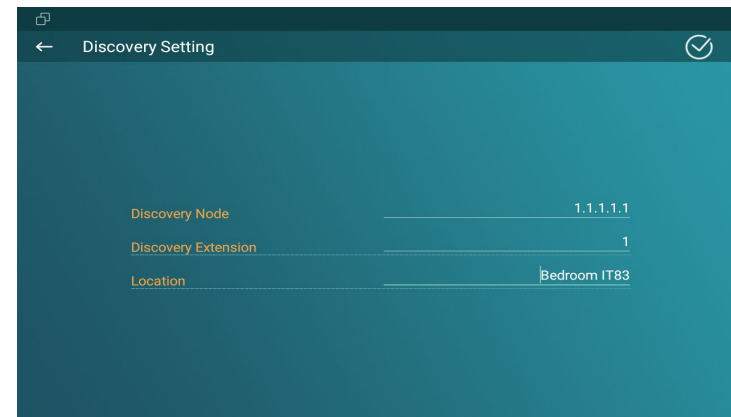

Figure 4.1.2-1 Discovery setting



**Discovery Extension/Device Extension:** To display the extension number of the device.

**Location/Device Location:** To enter the name/location to distinguish devices from each other.

On the web portal **Network - Advanced**, users can also make changes to the device connecting node.



Connect Setting	
Device Address	1 . 1 . 1 . 1 . 1
Device Extension	1
Device Location	Bedroom IT83

Figure 4.1.2-2 Discovery setting in web

## 4.2. Intercom

### 4.2.1. Call Forwarding

On the device, go to **More - Settings - Call Feature**.

**Account:** To choose which account shall implement call forwarding feature.

**Always forward:** All the incoming calls will be forwarded unconditionally to a specified number.

**Busy Forward:** The incoming calls will be forwarded to a specified number when IT83X is busy.

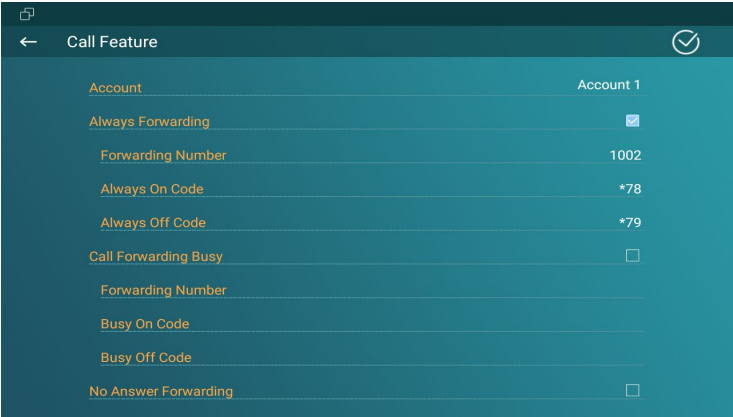

Call Feature	Value
Account	Account 1
Always Forwarding	<input checked="" type="checkbox"/>
Forwarding Number	1002
Always On Code	*78
Always Off Code	*79
Call Forwarding Busy	<input type="checkbox"/>
Forwarding Number	
Busy On Code	
Busy Off Code	
No Answer Forwarding	<input type="checkbox"/>

Figure 4.2.1-1 Call forwarding

**No answer Forward:** The incoming calls will be forwarded to a specified number when the ring tone is time out without answering.

**Always/Busy/No answer Forward:** Tick which forward users want to setup.

**Forwarding Number:** Enter the target numbers which users want to forward.

**On/off Code:** The code used to turn on/off forward feature on server's side, if configured, IT83X will send a sip message to server to turn on/off forward feature on server side if users press forward when forward feature is off/on.

On the web portal, go to **Phone - Call Feature** , users can also setup it.

## 4.2.2. Intercom

**Intercom:** To allow users establishing a call directly with the callee.

**Active:** To enable or disable Intercom function.

Forward Transfer	
Always Forward	Disabled ▼
Target Number	1002
Busy Forward	Enabled ▼
Target Number	1007
No Answer Forward	Disabled ▼
No Answer Ring Time	30 ▼
Target Number	1008

Figure 4.2.1-2 Web Forward

Intercom	
Active	Enabled ▼
Intercom Mute	Disabled ▼
Intercom Preview	Disabled ▼

Figure 4.2.2-1 Intercom

**Intercom Mute:** To eliminate the voice of the callee if enabled.

**Intercom Preview:** To enable preview function.

### 4.2.3. Subscribe

On the web portal, go to **Account - Advanced - Subscribe**.

**Subscribe:** To display and configure MWI, subscription settings.

**MWI Subscribe:** To enable or disable message waiting indicator function.

**MWI Subscribe Period:** To setup the time of MWI function.

**Voice Mail Number:** To fill in the voice mail number.



Subscribe	
MWI Subscribe	Enabled
MWI Subscribe Period	1800 (120~65535s)
Voice Mail Number	1004

Figure 4.2.3-1 Subscribe

### 4.2.4. Audio Codec

On the web portal, go to **Account - Advanced**.

**Audio Codecs:** To configure the disabled codecs and enabled codecs by pressing the corresponding buttons. Codec means

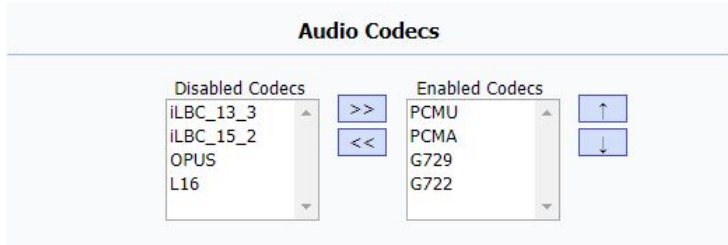

Audio Codecs	
Disabled Codecs	Enabled Codecs
iLBC_13_3	PCMU
iLBC_15_2	PCMA
OPUS	G729
L16	G722

Figure 4.2.4-1 Audio codes

coder-decoder which is used to transfer analog signal to digital signal or vice versa.

### 4.2.5. Video Codec

On the web portal, go to **Account - Advanced**.

**Video Codec:** To configure the disabled codecs and enabled codecs by pressing the corresponding buttons.

**Codec Resolution:** To adjust the resolutions for different video codecs.

**Codec Bitrate:** To adjust the bitrate for different video codecs.

**Codec Payload:** To adjust the codec payload for video codec.

### 4.2.6. NAT

On the web portal, go to **Account - Advanced**.

**UDP Keep Alive Message:** To send UDP keep alive message periodically to router to keep NAT port alive if enabled.

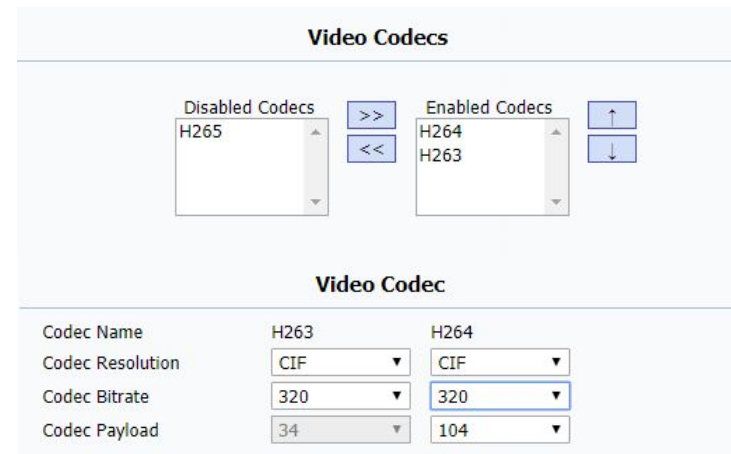

Figure 4.2.5-1 Video codec

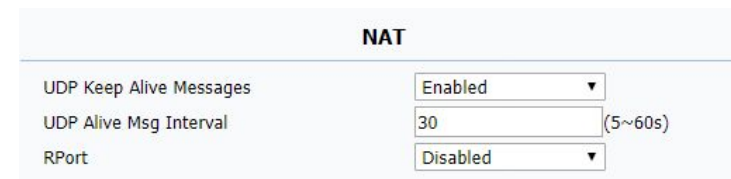

Figure 4.2.6-1 NAT

**UDP Alive Msg Interval:** To Keep alive message interval.

**RPort (Remote Port):** To add remote port in to outgoing SIP message for designated account if enabled.

## 4.2.7. User Agent

On the web portal, go to **Account - Advanced**.

**User Agent:** To customize user agent field in the SIP message. If user agent is set to specific value, users could see the information from SIP message. If user agent is not set by default, users could see the company name, model number and firmware version from SIP message.

## 4.2.8. DTMF

On the web portal, go to **Account - Advanced**.

**DTMF:** To configure RTP audio video profile for DTMF and its payload type.

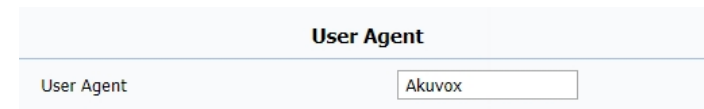

The screenshot shows a configuration panel titled "User Agent". Below the title, there is a label "User Agent" and a text input field containing the value "Akuvox".

Figure 4.2.7-1 User agent

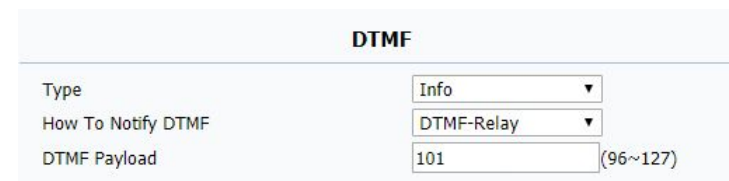

The screenshot shows a configuration panel titled "DTMF". It contains three rows of configuration options:

DTMF	
Type	Info
How To Notify DTMF	DTMF-Relay
DTMF Payload	101 (96~127)

Figure 4.2.8-1 DTMF

**Type:** Support Inband, Info, RFC2833 or their combination.

**How To Notify DTMF:** Only available when DTMF Type is Info.

**DTMF Payload:** To configure payload type for DTMF.

## 4.2.9. Encryption

On the web portal, go to **Account - Advanced**.

**Voice Encryption(SRTP):** If enabled, all audio signal (It's RTP streams indeed) will be encrypted for more security.

## 4.2.10. Call Related

**Max/Min Local Sip Port:** To configure maximum /minimum local SIP port for designated account.

**PTime:** Interval time between two consecutive RTP packets.

**Prevent SIP Hacking:** Enable to prevent SIP from hacking in the Internet.



Encryption	
Voice Encryption(SRTP)	Compulsory

Figure 4.2.9-1 Encryption



Call	
Max Local SIP Port	5062 (1024~65535)
Min Local SIP Port	5062 (1024~65535)
Auto Answer	Disabled
PTime	20
Prevent SIP Hacking	Disabled

Figure 4.2.10-1 Call related

## 4.2.11. Remote Control

On the web portal, go to **Phone - Call feature**.

**Remote Control** could allow specific host to interact with IT83X by sending HTTP or HTTPS requests. The specific action could be answering an incoming call, hangup an ongoing call and so on.

**Allowed Access IP List:** To configure the IP address of allowed host.

Remote Control	
Allowed Access IP List	<input type="text" value="192.168.35.115"/>

Figure 4.2.11-1 Remote control

## 4.2.12. Session Time Out

**Session Time Out:** To set the time out value, the ongoing call will be disconnected automatically if session time out.

Session Time Out	
Session Time Out Value	<input type="text" value="300"/> (60~14400s)

Figure 4.2.12-1 Session time out

## 4.3. Access Control

### 4.3.1. Web Relay

On the web portal, go to **Phone - Relay - Webrelay**.

**IP Address:** To fill in the IP address of web relay.

**UserName:** To fill in the user name of the web relay.

**Password:** To fill in the password of the web relay.

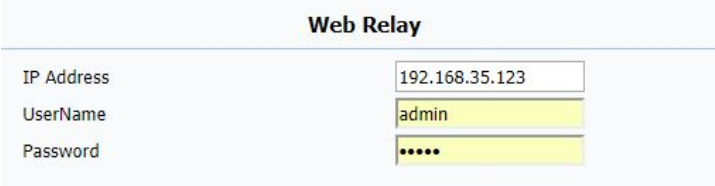

The screenshot shows a configuration form titled "Web Relay". It contains three input fields: "IP Address" with the value "192.168.35.123", "UserName" with the value "admin", and "Password" with masked characters "\*\*\*\*\*".

Figure 4.3.1-1 Web relay

### 4.3.2. Remote Relay by HTTP

On the web portal, go to **Phone - Relay**.

**Remote Relay By HTTP:** To configure the parameters to trigger a certain remote relay of door phone by sending http message, which also requires the configurations on door phone.

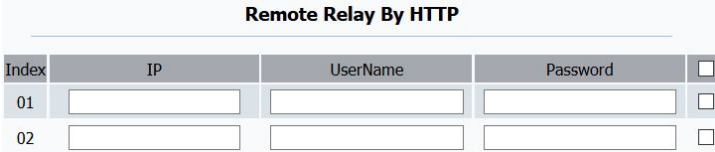

The screenshot shows a table titled "Remote Relay By HTTP" with the following structure:

Index	IP	UserName	Password	<input type="checkbox"/>
01	<input type="text"/>	<input type="text"/>	<input type="text"/>	<input type="checkbox"/>
02	<input type="text"/>	<input type="text"/>	<input type="text"/>	<input type="checkbox"/>

Figure 3.9-1 Remote relay by HTTP



## 4.4. Security

### 4.4.1. Arming Zone Setting

On the device, go to **More - Settings - More - Arming**.

Arming function is very useful for home safety. IT83X supports 8 zones to connect different alarm detection devices for different zones. IT83X does not provide the power for detection devices, connecting the GND and IOX terminal (For example, enable the zone 1, users need to connect IO1 and GND).

**Location:** To select which location the detection device is in, including Bedroom, Guest room, Hall, Window, Balcony, Kitchen, Study and Bathroom.

**Type:** To select which type of detection device is, including Infrared, Drmagnet, Smoke, Gas and Urgency..

**Trigger Mode:** To setup triggering mode for the sensor, including NO (normal open) and NC (normal closed).

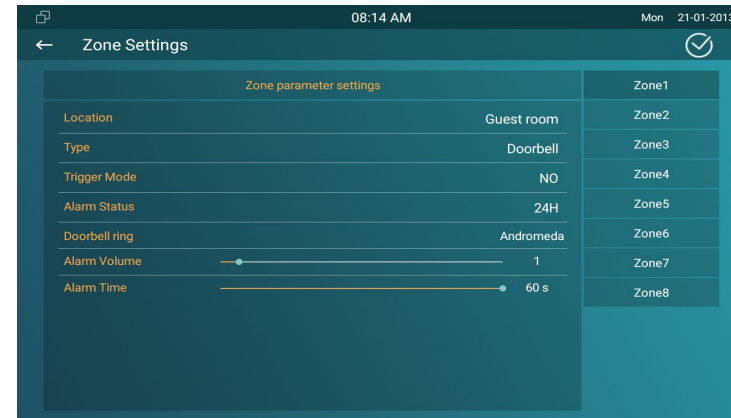

Figure 4.4.1-1 Zone setting

**Alarm Status:** To setup status of alarm sensor, including enable, disable and 24H.

**Note:** Disable status of detector means it cannot be triggered, 24H status means it cannot be disabled. Enable status means it depends on arming mode.

## 4.4.2. Motion Detector

Users could choose to display **Motion Detector** on the home/more page, please refer to chapter 3.4.10. IT83X could receive the captured motion pictures from the door phone, which requires the configurations on door phone.

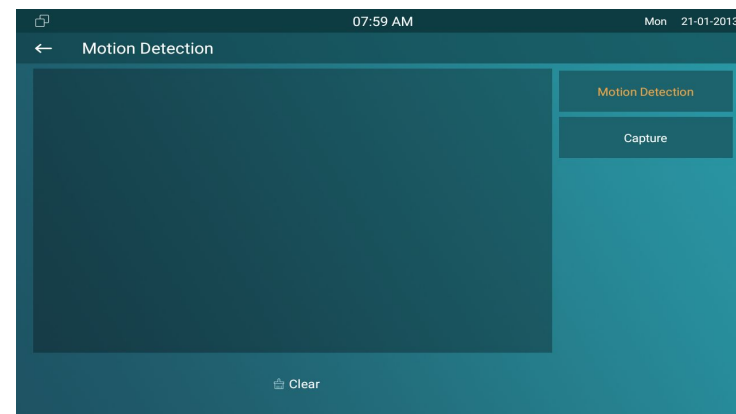

Figure 4.4.2-1 Motion detection

## 4.5. Upgrade

### 4.5.1. Basic Upgrade

On the web portal, go to **Upgrade - Basic**.

**Firmware Version:** To display the firmware version at present.

**Hardware Version:** To display the hardware version at present.

**Upgrade:** To select the upgrading file from PC manually.

**Submit:** To submit the upgrading file to IT83X.

**Cancel:** To cancel submitting the upgrading file.

### 4.5.2. Autop

Autop (Auto-Provisioning), this feature is used to configure or upgrade IT83X in batch via the support of third party servers.

To use DHCP/PNP/TFTP/FTP/HTTP/HTTPS servers to get URL, and then download firmware and/or its corresponding configuration files from servers. These configuration files and firmware will be



The screenshot shows a web portal interface for the 'Basic Upgrade' section. It displays the current 'Firmware Version' as 83.31.2.330 and the 'Hardware Version' as 1.0. Below this information, there is an 'Upgrade' section with a 'Select File' button, a text label 'Not selected any files', and two buttons: 'Submit' and 'Cancel'.

Figure 4.5.1-1 Basic upgrade

used to update firmware and the corresponding parameters on the phone.

### 4.5.2.1. PNP Autop

**PNP (Plug and Play):** To enable or disable Plug and Play feature, which will send SIP subscription message to PNP server automatically to get auto provisioning server's address if enabled. By default, this SIP message is sent to multicast address 224.0.1.75 (PNP server address by standard).

### 4.5.2.2. DHCP Autop

**DHCP Option:** To use designated DHCP option to get auto provisioning server's address via DHCP.

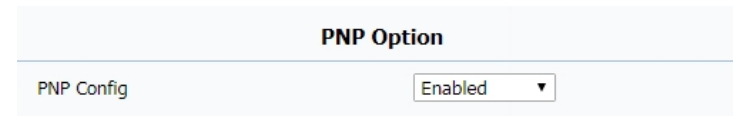

Figure 4.5.2.1-1 PNP Option

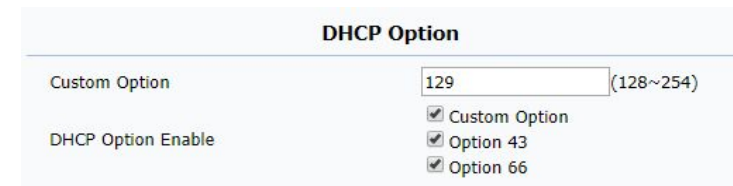

Figure 4.5.2.2-1 DHCP option

### 4.5.2.3. Manual Autop

**Manual Autop:** To display and configure manual update server's settings.

**URL:** To fill in the Auto provisioning server address.

**User Name:** To fill in the user name if server needs an username to access, otherwise left blank.

**Password:** To fill in the password if server needs a password to access, otherwise left blank.

**Common AES Key:** To decipher common auto provisioning configuration file for IT83X.

**AES Key (MAC):** Used for IP phone to decipher MAC-oriented auto provisioning configuration file (For example, file name could be 0C1105888888.cfg if IT83X's MAC address is 0C1105888888).

**Notes:** AES is one of many encryption, it should be configured only when configure file is ciphered with AES, otherwise left blank.

Manual Autop	
URL	tftp://192.168.35.115
User Name	admin
Password	....
Common AES Key	.....
AES Key(MAC)	.....

AutoP Immediately

Figure 4.5.2.3-1 Manual autop

### 4.5.2.4. Automatic Autop

**Automatic Autop:** To display and configure auto provisioning mode settings. It is actually self-explanatory. For example, mode “Power on” means IT83X will go to do provisioning every time it powers on.

**Note:** Please check more details in autop feature guide .

The screenshot shows the 'Automatic Autop' configuration interface. It includes a dropdown menu for 'Mode' set to 'Power On+Repeatedly', a dropdown for 'Schedule' set to 'Every Day', and input fields for 'Hour(0~23)' set to '22' and 'Min(0~59)' set to '0'. Below these fields are two buttons: 'Submit' and 'Export'.

Figure 4.5.2.4-1 Automatic autop

## 4.6. Logs

### 4.6.1. Call log

On the web portal, go to **PhoneBook - Call Log**. Users are able to view all /dialed /received /missed /forwarded calls.

**Call History:** To select which kind of calls users want to view, including dialed, received, missed and forwarded.

**Export:** To export the call log.

The screenshot shows the 'Call Log' interface with a 'Call History' table. The table has columns for Index, Type, Date, Time, Local Identity, Name, and Number. There are also buttons for 'Hand Up' and 'Export'. The table contains 7 rows of call data.

Index	Type	Date	Time	Local Identity	Name	Number
1	Received	2018-09-19	04:59:49	192.168.35.2 41@192.168.35.241	Jocelyn	<a href="#">192.168.35.205@192.168.35.205</a>
2	Missed	2018-09-19	04:59:09	192.168.35.2 41@192.168.35.241	Jocelyn	<a href="#">192.168.35.205@192.168.35.205</a>
3	Dialed	2018-09-19	04:49:56	192.168.35.2 41@192.168.35.241	Jocelyn	<a href="#">192.168.35.205@192.168.35.205</a>
4	Dialed	2018-09-19	04:44:34	1004@192.168.35.230:5060	Daniel	<a href="#">1006@192.168.35.230:5060</a>
5	Dialed	2018-09-19	04:44:28	1004@192.168.35.230:5060	Daniel	<a href="#">1006@192.168.35.230:5060</a>
6	Dialed	2018-09-19	04:43:27	1004@192.168.35.230:5060	Daniel	<a href="#">1006@192.168.35.230:5060</a>
7	Dialed	2018-09-19	04:42:58	1004@192.168.35.230:5060	Daniel	<a href="#">1006@192.168.35.230:5060</a>

Figure 4.6.1-1 Call log

## 4.6.2. System Log

On the web portal, go to **Upgrade - Advanced**. System log provides a professional method for administrator to debug .

**System Log:** To display system log level and export system log file.

**Log level:** To adjust the system log level, which ranges from 0 to 7 and it is 3 by default. The higher level means the more specific system log is saved to a temporary file.

**Export Log:** To export temporary system log file to local PC.

**Remote System Log:** To enable/disable remote system Log.

**Remote System Server:** To input the syslog server address.

## 4.6.3. PCAP

On the web portal, go to **Upgrade - Advanced - PCAP**. PCAP is a network packet capture tool in IT83X itself, which provides an efficient method to troubleshoot network problems.

**PCAP Start:** To start PCAP if users click **Start** button.



System Log	
LogLevel	3 ▼
Export Log	Export
Remote System Log	Enabled ▼
Remote System Server	192.168.35.115

Figure 4.6.2-1 System log

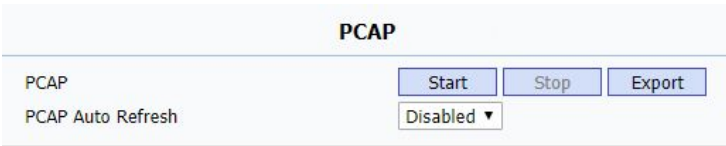

PCAP	
PCAP	Start Stop Export
PCAP Auto Refresh	Disabled ▼

Figure 4.6.3-1 PCAP

**PCAP Stop:** To stop PCAP if users click **Stop** button.

**Export:** To export the PCAP after capturing of packets.

**PCAP Auto Refresh:** To enable or disable PCAP auto refresh.



## Abbreviations

**ACS:** Auto Configuration Server

**Auto:** Automatically

**AEC:** Configurable Acoustic and Line Echo Cancelers

**ACD:** Automatic Call Distribution

**Autop:** Automatical Provisioning

**AES:** Advanced Encryption Standard

**BLF:** Busy Lamp Field

**COM:** Common

**CPE:** Customer Premise Equipment

**CWMP:** CPE WAN Management Protocol

**DTMF:** Dual Tone Multi-Frequency

**DHCP:** Dynamic Host Configuration Protocol

**DNS:** Domain Name System

**DND:** Do Not Disturb

**DNS-SRV:** Service record in the Domain Name System

**FTP:** File Transfer Protocol

**GND:** Ground

**HTTP:** Hypertext Transfer Protocol

**HTTPS:** Hypertext Transfer Protocol Secure

**IP:** Internet Protocol

**ID:** Identification

**IR:** Infrared

**LCD:** Liquid Crystal Display

**LED:** Light Emitting Diode

**MAX:** Maximum

**POE:** Power Over Ethernet

**PCMA:** Pulse Code Modulation A-Law

**PCMU:** Pulse Code Modulation  $\mu$ -Law

**PCAP:** Packet Capture

**PNP:** Plug and Play

**RFID:** Radio Frequency Identification

**RTP:** Real-time Transport Protocol

**RTSP:** Real Time Streaming Protocol

**MPEG:** Moving Picture Experts Group

**MWI:** Message Waiting Indicator

**NO:** Normal Opened

**NC:** Normal Connected

**NTP:** Network Time Protocol

**NAT:** Network Address Translation

**NVR:** Network Video Recorder

**ONVIF:** Open Network Video Interface Forum

**SIP:** Session Initiation Protocol

**SNMP:** Simple Network Management Protocol

**STUN:** Session Traversal Utilities for NAT

**SMTP:** Simple Mail Transfer Protocol

**SDMC:** SIP Devices Management Center

**TR069:** Technical Report069

**TCP:** Transmission Control Protocol

**TLS:** Transport Layer Security

**TFTP:** Trivial File Transfer Protocol

**UDP:** User Datagram Protocol

**URL:** Uniform Resource Locator

**VLAN:** Virtual Local Area Network

**WG:** Wiegand

## Contact us

For more information about the product, please visit us at [www.akuvox.com](http://www.akuvox.com) or feel free to contact us by

Sales email: [sales@akuvox.com](mailto:sales@akuvox.com)

Technical support email: [techsupport@akuvox.com](mailto:techsupport@akuvox.com)

Telephone: +86-592-2133061 ext.7694/8162

**We highly appreciate your feedback about our products.**

